



Low Voltage Cables

Product Catalogue



Factories and Regional Offices

Tai Sin Electric Limited

24 Gul Crescent

Jurong Town

Singapore 629531

Tel: (+65) 6672 9292

Fax: (+65) 6861 4084

E-Mail: sales@taisin.com.sg

Website: www.taisin.com.sg

Tai Sin Electric Cables (Malaysia) Sdn. Bhd.

PTD 37433 & 37434

Off Jalan Perindustrian Senai 3

Kawasan Perindustrian Senai Fasa 3

P.O.Box 73, 81400 Senai

Johor Darul Takzim, Malaysia

Tel: (+60) 7 599 8888

Fax: (+60) 7 599 8898

E-Mail: sales@taisin.com.my

Website: www.taisin.com.my

Tai Sin Electric Cables (VN) Co., Ltd.

No.20, VSIP II Street 2

Viet Nam - Singapore Industrial Park 2

Hoa Phu Ward, Thu Dau Mot Town

Binh Duong Province, Vietnam

Tel: (+84) 650 3635 088

Fax: (+84) 650 3635 077

E-Mail: sales@taisin.com.vn

Website: www.taisin.com.vn

(Updated as at February 2012)



INTRODUCTION		1
HOW TO READ THIS CATALOGUE / APPLICABLE STANDARDS		2
BARE ANNEALED COPPER & PVC INSULATED CABLES		
BARE COPPER	STRANDED PLAIN ANNEALED COPPER CONDUCTOR (SINGLE CORE) IEC60228, BS EN60228	4
PVC	CU / PVC (SINGLE CORE) PVC Insulated, Non-Sheathed Cable, 450 / 750V, SS358, BS6004, IEC60227	5
PVC	CU / PVC (SWITCHBOARD WIRES SINGLE CORE) PVC Insulated, Non-Sheathed Cable, 0.6 / 1kV, BS6231	6
PPS	CU / PVC / PVC (SINGLE CORE) PVC Insulated, PVC Sheathed Cable, 0.6 / 1kV, IEC60502	7
PPM	CU / PVC / PVC (2 CORES - 5 CORES) PVC Insulated, PVC Sheathed Cable, 0.6 / 1kV, IEC60502	8
PCC	CU / PVC / PVC (MULTI-CORES) PVC Insulated, PVC Sheathed Cable, 0.6 / 1kV, BS6346	10
PAP	CU / PVC / PVC / AWA / PVC (SINGLE CORE) PVC Insulated, PVC Bedded, Aluminium Wire Armoured, PVC Sheathed Cable, 0.6 / 1kV, BS6346	12
PSP	CU / PVC / PVC / SWA / PVC (2 CORES - 5 CORES) PVC Insulated, PVC Bedded, Galvanised Steel Wire Armoured, PVC Sheathed Cable, 0.6 / 1kV, BS6346	13
PSP	CU / PVC / PVC / SWA / PVC (MULTI-CORES) PVC Insulated, PVC Bedded, Galvanised Steel Wire Armoured, PVC Sheathed Cable, 0.6 / 1kV, BS6346	15
FLEXI-IMP	(SINGLE CORE, 2 CORES - 4 CORES) PVC Insulated Flexible Cable, PVC Insulated PVC Sheathed Flexible Cable, 250V / 440V, Imperial Unit BS 2004	17
XLPE INSULATED CABLES		
XP	CU / XLPE / PVC (SINGLE CORE) XLPE Insulated, PVC Sheathed Cable, 0.6 / 1kV, IEC60502	18
XP	CU / XLPE / PVC (2 CORES - 5 CORES) XLPE Insulated, PVC Sheathed Cable, 0.6 / 1kV, IEC60502	19
XP	CU / XLPE / PVC (MULTI-CORES) XLPE Insulated, PVC Sheathed Cable, 0.6 / 1kV, IEC60502	21
XAP	CU / XLPE / PVC / AWA / PVC (SINGLE CORE) XLPE Insulated, PVC Bedded, Aluminium Wire Armoured, PVC Sheathed Cable, 0.6 / 1kV, IEC60502	23
XSP	CU / XLPE / PVC / SWA / PVC (2 CORES - 5 CORES) XLPE Insulated, PVC Bedded, Galvanised Steel Wire Armoured, PVC Sheathed Cable, 0.6 / 1kV, IEC60502	24
XSP	CU / XLPE / PVC / SWA / PVC (MULTI-CORES) XLPE Insulated, PVC Bedded, Galvanised Steel Wire Armoured, PVC Sheathed Cable, 0.6 / 1kV, IEC60502	26
XCP	CU / XLPE / PVC / CT / PVC (3 CORES + 3 EARTH) XLPE Insulated, PVC Bedded, Copper Tape Screened, PVC Sheathed Cable, 0.6 / 1kV, IEC60502	28
XCP	CU / XLPE / PVC / CT / PVC (4 CORES) XLPE Insulated, PVC Bedded, Copper Tape Screened, PVC Sheathed Cable, 0.6 / 1kV, IEC60502	29
XCAP	CU / XLPE / PVC / CT / PVC / AWA / PVC (SINGLE CORE) XLPE Insulated, PVC Bedded, Copper Tape Screened, PVC Separation Sheath, Aluminium Wire Armoured, PVC Sheathed Cable, 0.6 / 1kV, IEC60502	30
XCSP	CU / XLPE / PVC / CT / PVC / SWA / PVC (4 CORES) XLPE Insulated, PVC Bedded, Copper Tape Screened, PVC Separation Sheath, Galvanised Steel Wire Armoured, PVC Sheathed Cable, 0.6 / 1kV, IEC60502	31

LOW SMOKE ZERO HALOGEN FLAME RETARDANT CABLES

FRT-H	CU / LSZH (SINGLE CORE) Cross-Linked LSZH Insulated, Non-Sheathed Cable, 450 / 750V (0.6 / 1kV*), BS7211	32
FRT-XH	CU / XLPE / LSZH (SINGLE CORE) XLPE Insulated, LSZH Sheathed Cable, 0.6 / 1kV, IEC60502	33
FRT-XH	CU / XLPE / LSZH (2 CORES - 5 CORES) XLPE Insulated, LSZH Sheathed Cable, 0.6 / 1kV, IEC60502	34
FRT-XH	CU / XLPE / LSZH (MULTI-CORES) XLPE Insulated, LSZH Sheathed Cable, 0.6 / 1kV, IEC60502	36
FRT-XAH	CU / XLPE / LSZH / AWA / LSZH (SINGLE CORE) XLPE Insulated, LSZH Bedded, Aluminium Wire Armoured, LSZH Sheathed Cable, 0.6 / 1kV, BS6724	38
FRT-XSH	CU / XLPE / LSZH / SWA / LSZH (2 CORES - 5 CORES) XLPE Insulated, LSZH Bedded, Galvanised Steel Wire Armoured, LSZH Sheathed Cable, 0.6 / 1kV, BS6724	39
FRT-XSH	CU / XLPE / LSZH / SWA / LSZH (MULTI-CORES) XLPE Insulated, LSZH Bedded, Galvanised Steel Wire Armoured, LSZH Sheathed Cable, 0.6 / 1kV, BS6724	41
FRT-XCH	CU / XLPE / LSZH / CT / LSZH (3 CORES + 3 EARTH) XLPE Insulated, LSZH Bedded, Copper Tape Screened, LSZH Sheathed Cable, 0.6 / 1kV, IEC60502	43
FRT-XCH	CU / XLPE / LSZH / CT / LSZH (4 CORES) XLPE Insulated, LSZH Bedded, Copper Tape Screened, LSZH Sheathed Cable, 0.6 / 1kV, IEC60502	44
FRT-XCAH	CU / XLPE / LSZH / CT / LSZH / AWA / LSZH (SINGLE CORE) XLPE Insulated, LSZH Bedded, Copper Tape Screened, LSZH Separation Sheath, Aluminium Wire Armoured, LSZH Sheathed Cable, 0.6 / 1kV, IEC60502	45
FRT-XCSH	CU / XLPE / LSZH / CT / LSZH (4 CORES) XLPE Insulated, LSZH Bedded, Copper Tape Screened, LSZH Separation Sheath, Galvanised Steel Wire Armoured, LSZH Sheathed Cable, 0.6 / 1kV, IEC60502	46

LOW SMOKE ZERO HALOGEN FLAME RETARDANT FIRE RESISTANT CABLES

FR-H	CU / MGT / LSZH (SINGLE CORE) Mica Taped, Cross-linked Polyolefin LSZH Insulated, Non-Sheathed Cable, 450 / 750V (0.6 / 1kV*), BS7211	47
FR-XH	CU / MGT / XLPE / LSZH (SINGLE CORE) Mica Taped, XLPE Insulated, LSZH Sheathed Cable, 0.6 / 1kV, IEC60502	48
FR-XH	CU / MGT / XLPE / LSZH (2 CORES - 5 CORES) Mica Taped, XLPE Insulated, LSZH Sheathed Cable, 0.6 / 1kV, IEC60502	49
FR-XH	CU / MGT / XLPE / LSZH (MULTI-CORES) Mica Taped, XLPE Insulated, LSZH Sheathed Cable, 0.6 / 1kV, IEC60502	51
FR-XAH	CU / MGT / XLPE / LSZH / AWA / LSZH (SINGLE CORE) Mica Taped, XLPE Insulated, LSZH Bedded, Aluminium Wire Armoured, LSZH Sheathed Cable, 0.6 / 1kV, IEC60502	53
FR-XSH	CU / MGT / XLPE / LSZH / SWA / LSZH (2 CORES - 5 CORES) Mica Taped, XLPE Insulated, LSZH Bedded, Galvanised Steel Wire Armoured, LSZH Sheathed Cable, 0.6 / 1kV, BS7846	54
FR-XSH	CU / MGT / XLPE / LSZH / SWA / LSZH (MULTI-CORES) Mica Taped, XLPE Insulated, LSZH Bedded, Galvanised Steel Wire Armoured, LSZH Sheathed Cable, 0.6 / 1kV, BS7846	56
FR-XL	CU / MGT / XLPE / LSZH (MULTI-CORES) Mica Taped, XLPE Insulated, LSZH Sheathed Cable, 300 / 500V, BS EN50288-7	58
FR-XOL	CU / MGT / XLPE / OS / LSZH (SINGLE PAIR) Mica Taped, XLPE Insulated, Overall Aluminium Foil Screened, LSZH Sheathed Cable, 300 / 500V, BS EN50288-7	60

APPENDIX A - E

Appendix A - Schedule of Installation Methods of Cables	61
Appendix B - Current Rating Capacity & Voltage Drop	66
Appendix C - Rating Factors	74
Appendix D - Cable Cores Colour Code	79
Appendix E - Fire Performance Tests and Standards	80

TERMS & CONDITIONS OF SALES



Since our incorporation in 1980 as Tai Sin Electric Cables Manufacturer Pte Ltd, we have expanded and diversified over the past three decades to establish ourselves as the present Tai Sin Electric Limited. To cater for the robust growth in the regional market, Tai Sin now operates three cable manufacturing plants located in Singapore, Malaysia and Vietnam, all of which are fully equipped with the latest manufacturing facilities and technologies to meet increasing demands.

Tai Sin stocks the widest range of the Power, Control, Instrumentation and Safety Cables for use in all areas of electrical and instrumentation installation for commercial, residential, industrial and infrastructure projects. Our cables and wires are manufactured under strict quality control and designed to perform within fixed parameters of electrical, mechanical and environmental tolerances and we assure you that our products will not present a safety hazard if used with care.

For 30 years, we have grown steadily based on a sound business philosophy of providing quality products using leading edge technology, backed by unfailing excellence in customer service and faster turnaround time to maintain customer loyalty. These are the beliefs and values that give us the strength and confidence to continue to grow, excel and succeed in the exciting years ahead.

This catalogue illustrates the construction of our standard range of PVC & XLPE Cables & Wires, our Eco-Friendly, Non-Toxic range of Low Smoke Zero Halogen Flame Retardant Cables and our range of Low Smoke Zero Halogen Flame Retardant Fire Resistant Cables comply to various local and international standards.

Every possible effort has been made to ensure that the information contained in this publication is correct and current at the time of printing. Tai Sin reserves the right to change the information and/or specifications at any time without notice in light of technical improvement and continued development.

Reference to or extracts from the Singapore Standards (SS), British Standards (BS), International Electrotechnical Commission Standards (IEC), Singapore Productivity & Standard Board CP5:1998 manual, current IEE Wiring Regulations or other regulatory bodies are made with the belief that they are true and accurate. Users are recommended to verify such claims with the respective organisations independently.



Tables and data in Appendices A, B & C in this catalogue have been extracted with thanks from the IEE Wiring Regulations, 17th Edition and BS 7671: 2008.

We hope that this catalogue will be useful to engineers and end-users to serve as their full reference guidelines.



This catalogue consists of three types of Low Voltage Cables and they are categorized into three different sections, 1) PVC & XLPE Insulated Cables, 2) Low Smoke Zero Halogen Flame Retardant Cables and 3) Low Smoke Zero Halogen Flame Retardant Fire Resistant Cables. In each section, the cables are further categorized by its electrical component and conductor sizes, which ranges from 0.5mm² to 1000mm², armoured and non- armoured and with or without copper-taped screened.

In this catalogue we have given each cable a name accompanied with the various short and long descriptions based on its material used.

For example:

FR-XSH

CU / MGT / XLPE / LSZH / SWA / LSZH (2 CORES - 5 CORES)

Mica Taped, XLPE Insulated, LSZH Bedded, Galvanised Steel Wire Armoured, LSZH Sheathed Cable, 0.6 / 1kV, BS7846

← This is the short description

← Full description on the third line

To better understand the contents of the cable, we have included a 3-dimensional image plus a cross-sectional image of the cable for easy reference of its structure and components. The technical specifications and figures are provided by our quality team to ensure the accurate use of our products. Technical properties such as Current Rating Factor and Voltage drop, and other essential technical details are provided in the Appendices at the last section of this catalogue. The latest Cable Installation Methods as well as the new harmonized wiring colour codes (as per IEE Wiring Regulations, 17th Edition) are also provided in our Appendices for your easy reference.

For all other enquiries, please feel free to contact our friendly customer service hotline for further assistance.

APPLICABLE STANDARDS

Below are the applicable standards that are used as reference in the construction of our low voltage cables.

ASTM D 2863

Measuring the minimum oxygen concentration to support candle-like combustion of plastic (oxygen index).

BS2004

PVC insulated cables and flexible cords for electric power and lighting.

BS6004

Electric cables, PVC insulated, non-armoured cables for voltages up to and including 450 / 750V, for electric power, lighting and internal wiring.

BS6231

Electric cables, single-core PVC insulated flexible cables of rated voltage 600 / 1000V for switchgear and control-gear wiring.

BS6346

Electric cables, PVC insulated, armoured cables for voltages of 600 / 1000V and 1900 / 3300V.

BS6360

(withdrawn and replaced by BS EN 60228:2005) Specification for conductors in insulated cables and cords.

BS6387 / SS299

Performance requirements for cables required to maintain circuit integrity under fire conditions.

BS6724

600 / 1000V armoured electric cables having thermosetting insulation and low emission of smoke and corrosive gases when affected by fire.

BS7211

Thermosetting insulated cables (non- armoured) for electric power and lighting with low emission of smoke and corrosive gases when affected by fire.

APPLICABLE STANDARDS

Below are the applicable standards that are used as reference in the construction of our low voltage cables.



BS7629-1

300 / 500V fire-resistant screened cables having low emission of smoke and corrosive gases when affect by fire.
Part 1: Multicore and Multi-pair Cables.

BS7846

600 / 1000V armoured fire-resistant electric cables having low emission of smoke and corrosive gases when affected by fire.

BS EN50288-7

Multi-element metallic cables use in analogue and digital communication and control.
Part 7: Sectional specification for instrumentation and control cables.

BS EN60228

Conductors of insulated cables.

BS EN60332-1

Tests on electric and optical fibre cables under fire conditions.
Test for vertical flame propagation for a single insulated wire or cable.

BS EN60332-3-22

Tests on electric and optical fibre cables under fire conditions.
Part 3-22: Test for vertical flame spread of vertically-mounted bunched wires or cables (Category A).

IEC60227-3

Polyvinyl Chloride insulated cables of rated voltages up to and including 450 / 750V Part 3: Non-sheathed cables for fixed wiring.

IEC60228

Conductors of insulated cables.

IEC60331

Fire-resistant characteristics of electric cables.

IEC60332-1 / BS4066-1 / BS EN50266-1

Tests in electric cables under fire conditions.
Part 1: Method of test on a single vertical insulated wire or cable.

IEC60332-3 / BS4066-3 / BS EN50266-2

Tests on electric cables under fire conditions.
Part 3: Methods of classification of flame propagation characteristics of bunched cables.

IEC60332-3-22

Tests on electric and optical fibre cables under fire conditions.
Part 3-22: Test for vertical flame spread of vertically-mounted bunched wires or cables (Category A).

IEC60502-1

Power cables with extruded insulation and their accessories for rated voltages from 1kV up to 30kV.
Part 1: Cables for Rated Voltages of 1kV and 3kV.

IEC60754-1 / BS6425-1 / BS EN50267-2-1

Tests on gases evolved during the combustion of materials from cables.
Part 1: Methods of determination of amount of halogen acid gas evolved during combustion of polymeric materials taken from cables.

IEC60754-2 / BS6425-2 / BS EN50267-2-2

Tests on gases evolved during combustion of materials from cables.
Part 2: Determination of degree of acidity (corrosive) of gases by measuring pH and conductivity.

IEC61034-2 / BS7622-2 / BS EN61034-2

Measurement of smoke density of electric cables burning under defined conditions.
Part 2: Test procedure and requirements.

SS358-3

Polyvinyl Chloride insulated cables of rated voltages up to and including 450 / 750V.
Part 3: Non-sheathed cables for fixed wiring.

Bare Annealed Copper

STRANDED PLAIN ANNEALED COPPER CONDUCTOR (SINGLE CORE)

IEC60228, BS EN 60228

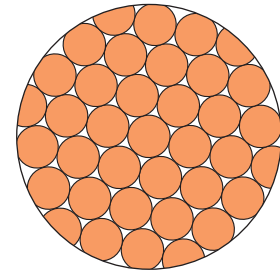

CONSTRUCTION

Conductor: Plain Annealed Copper, Class 2 Stranded Circular or Compacted

REFERENCE STANDARDS

Conductor: IEC60228, BS EN60228

Minimum Bending Radius: 3D for $D < 10\text{mm}$
4D for $10\text{mm} \leq D < 25\text{mm}$
6D for $D \geq 25\text{mm}$

Nominal Conductor Area (mm ²)	No. and Diameter of Wires (no./mm)	Nominal Diameter of Conductor (mm)	Maximum Conductor Resistance at 20°C (Ω/km)	Nominal Weight per km of Conductor (kg/km)
1.0	7 / 0.43	1.29	18.1	9.2
1.5	7 / 0.53	1.59	12.1	14.0
2.5	7 / 0.67	2.01	7.41	22.4
4	7 / 0.85	2.55	4.61	36.1
6	7 / 1.04	3.12	3.08	54.0
10	7 / 1.35	4.05	1.83	90.8
16	7 / 1.70	5.10	1.15	145.0
25	7 / 2.14	6.42	0.727	229.0
35	7 / 2.52	7.56	0.524	317.0
50	19 / 1.78	8.90	0.387	429.0
70	19 / 2.14	10.70	0.268	620.0
95	19 / 2.52	12.60	0.193	860.0
120	37 / 2.03	14.21	0.153	1086.0
150	37 / 2.25	15.75	0.124	1334.0
185	37 / 2.52	17.64	0.0991	1673.0
240	61 / 2.25	20.25	0.0754	2199.0
300	61 / 2.52	22.68	0.0601	2759.0
400	61 / 2.85	25.65	0.0470	3528.0
500	61 / 3.20	28.80	0.0366	4448.0
630	127 / 2.52	32.76	0.0283	5744.0
800	127 / 2.85	37.05	0.0221	7346.0
1000	127 / 3.20	41.60	0.0176	9260.0

Table 1

PVC

CU / PVC (SINGLE CORE)

PVC Insulated, Non-Sheathed Cable, 450 / 750V, SS358, BS6004, IEC60227

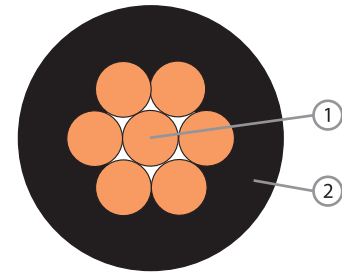

Component
1. Plain Annealed Copper Wire
2. PVC Compound

CONSTRUCTION

Conductor:	Plain Annealed Copper, Class 2 Stranded Circular or Compacted
Insulation:	Polyvinyl Chloride (PVC) Compound Type C
Insulation Colour:	Black, Green/Yellow, Red, Yellow, Blue, White, Brown, Grey or Others

REFERENCE STANDARDS

Design Specification:	SS358, BS6004, IEC60227
Conductor:	IEC60228, BS EN60228
Flame Retardancy:	IEC60332-1, BS EN60332-1

ELECTRICAL CHARACTERISTICS

Operating Voltage, U ₀ /U:	450/750V
Operating Temperature:	-15°C to 70°C
Final Short Circuit Temperature:	160°C for cable ≤ 300mm ² 140°C for cable >300mm ²
Test Voltage:	2.5kV for 5 minutes

INSTALLATION REFERENCE

Min. Bending Radius (mm):	6 x cable overall diameter
Max. Pulling Tension (N/mm ²):	50

	Nominal Conductor Area (mm ²)	No. and Diameter of Wires (no./mm)	Radial Thickness of Insulation (mm)	Mean Overall Diameter (Upper Limit) (mm)	Approximate Weight (kg/km)
SINGLE CORE	1 x 1.5	7 / 0.53	0.7	3.4	22.7
	1 x 2.5	7 / 0.67	0.8	4.2	34.0
	1 x 4	7 / 0.85	0.8	4.8	50.0
	1 x 6	7 / 1.04	0.8	5.4	70.9
	1 x 10	7 / 1.35	1.0	6.8	117.5
	1 x 16	7 / 1.70	1.0	8.0	177.4
	1 x 25	7 / 2.14	1.2	9.8	282.0
	1 x 35	7 / 2.52	1.2	11.0	380.3
	1 x 50	19 / 1.78	1.4	13.0	515.8
	1 x 70	19 / 2.14	1.4	15.0	726.4
	1 x 95	19 / 2.52	1.6	17.0	1002.9
	1 x 120	37 / 2.03	1.6	19.0	1251.0
	1 x 150	37 / 2.25	1.8	21.0	1538.7
	1 x 185	37 / 2.52	2.0	23.5	1927.9
	1 x 240	61 / 2.25	2.2	26.5	2522.6
	1 x 300	61 / 2.52	2.4	29.5	3155.2
	1 x 400	61 / 2.85	2.6	33.5	4018.0
	1 x 500	61 / 3.20	2.8	37.0	5044.9
	1 x 630	127 / 2.52	2.8	41.0	6443.4

For current rating and voltage drop, please refer to Table B1.1 and B2.1 on Page 66.

Table 2

PVC

CU / PVC (SWITCHBOARD WIRES SINGLE CORE)

PVC Insulated, Non-Sheathed Cable, 0.6 / 1kV, BS6231

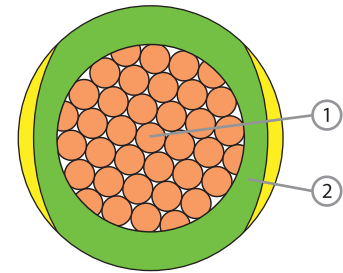
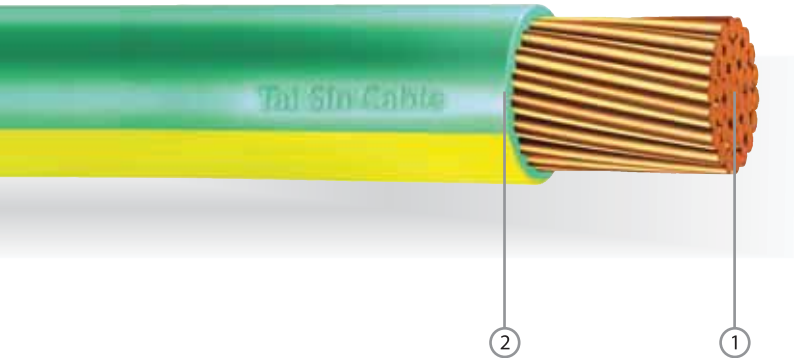

Component
1. Plain Annealed Copper Wire
2. PV Compound

CONSTRUCTION

Conductor:	Plain Annealed Copper, Class 5 Stranded Circular or Compacted
Insulation:	Polyvinyl Chloride (PVC) Compound Type T11
Insulation Colour:	Black, Green/Yellow, Red, Yellow, Blue, White, Brown, Grey or Others

REFERENCE STANDARDS

Design Specification:	BS6231
Conductor:	IEC60228, BS EN60228
Flame Retardancy:	IEC60332-1, BS EN60332-1

ELECTRICAL CHARACTERISTICS

Operating Voltage, U ₀ /U:	0.6/1KV
Operating Temperature:	-15°C to 70°C
Final Short Circuit Temperature:	160°C
Test Voltage:	3.5kV for 5 minutes

INSTALLATION REFERENCE

Min. Bending Radius (mm):	6 x cable overall diameter
Max. Pulling Tension (N/mm ²):	50

SINGLE CORE	Nominal Conductor Area (mm ²)	No. and Diameter of Wires (no./mm)	Radial Thickness of Insulation (mm)	Mean Overall Diameter (Upper Limit) (mm)	Approximate Weight (kg/km)	Minimum Insulation Resistance at 70°C (MΩ · km)
		1 x 0.5	16 / 0.2	0.8	2.6	11.3
	1 x 0.75	24 / 0.2	0.8	2.8	14.5	0.0141
	1 x 1.0	32 / 0.2	0.8	3.0	17.5	0.0128
	1 x 1.5	30 / 0.25	0.8	3.3	23.0	0.0111
	1 x 2.5	50 / 0.25	0.8	3.7	34.0	0.0094
	1 x 4	56 / 0.3	0.8	4.3	50.2	0.0077
	1 x 6	84 / 0.3	0.8	4.9	71.0	0.0059
	1 x 10	80 / 0.4	1.0	6.3	119.3	0.0058
	1 x 16	128 / 0.4	1.0	7.4	181.3	0.0048
	1 x 25	200 / 0.4	1.2	9.1	280.9	0.0047
	1 x 35	280 / 0.4	1.2	10.3	382.3	0.0040
	1 x 50	400 / 0.4	1.4	12.2	544.1	0.0039
	1 x 70	356 / 0.5	1.4	13.8	739.9	0.0033
	1 x 95	485 / 0.5	1.6	16.1	1005.2	0.0032
	1 x 120	614 / 0.5	1.6	17.6	1255.7	0.0029
	1 x 150	765 / 0.5	1.8	19.7	1565.6	0.0029
	1 x 185	994 / 0.5	2.0	22.3	2028.7	0.0029
	1 x 240	1125 / 0.5	2.2	23.9	2304.1	0.0028

For current rating and voltage drop, please refer to Table B1.1 and B2.1 on Page 66.

Table 3

PPS

CU / PVC / PVC (SINGLE CORE)

PVC Insulated, PVC Sheathed Cable, 0.6/1kV, IEC60502

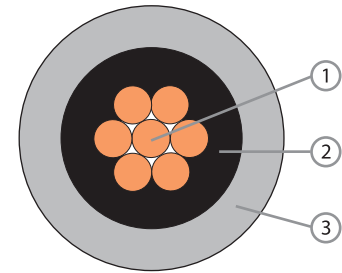
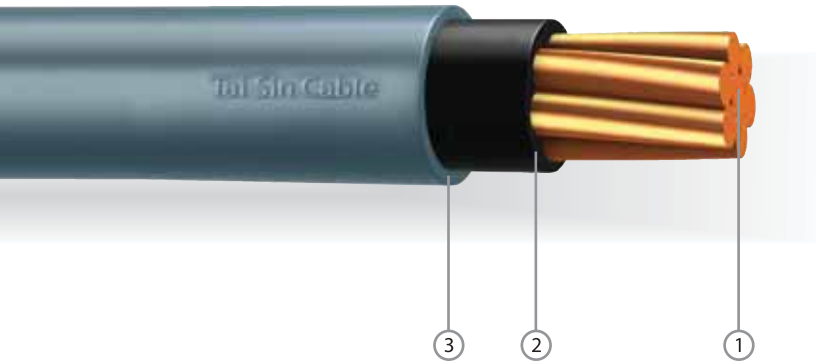

Component
 1. Plain Annealed Copper Wire
 2. PVC Compound
 3. PVC Compound

CONSTRUCTION

Conductor:	Plain Annealed Copper, Class 2 Stranded Circular or Compacted
Insulation:	Polyvinyl Chloride (PVC) Compound Type A
Insulation Colour:	Red or Black
Outer Sheath:	Polyvinyl Chloride (PVC) Compound Type ST 1
Outer Sheath Colour:	Grey

REFERENCE STANDARDS

Design Specification:	IEC60502-1
Conductor:	IEC60228, BS EN60228
Flame Retardancy:	IEC60332-1, BS EN60332-1

INSTALLATION REFERENCE

Min. Bending Radius (mm):	6 x cable overall diameter
Max. Pulling Tension (N/mm ²):	50

ELECTRICAL CHARACTERISTICS

Operating Voltage, U ₀ /U:	0.6/1KV
Operating Temperature:	-15°C to 70°C
Final Short Circuit Temperature:	160°C for cable ≤ 300mm ² 140°C for cable >300mm ²
Test Voltage:	3.5kV for 5 minutes

	Nominal Conductor Area (mm ²)	No. and Diameter of Wires (no./mm)	Radial Thickness of Insulation (mm)	Cable Overall Diameter (mm)	Approximate Weight (kg/km)
	1 x 1.5	7 / 0.53	0.8	6.3	68
	1 x 2.5	7 / 0.67	0.8	6.7	80
	1 x 4	7 / 0.85	1.0	7.7	108
	1 x 6	7 / 1.04	1.0	8.2	133
	1 x 10	7 / 1.35	1.0	9.2	180
	1 x 16	7 / 1.70	1.0	10.2	245
	1 x 25	7 / 2.14	1.2	11.9	357
	1 x 35	7 / 2.52	1.2	13.1	460
	1 x 50	19 / 1.78	1.4	14.8	604
	1 x 70	19 / 2.14	1.4	16.6	818
	1 x 95	19 / 2.52	1.6	19.1	1113
	1 x 120	37 / 2.03	1.6	20.7	1363
	1 x 150	37 / 2.25	1.8	22.9	1668
	1 x 185	37 / 2.52	2.0	25.3	2077
	1 x 240	61 / 2.25	2.2	28.6	2692
	1 x 300	61 / 2.52	2.4	31.6	3345
	1 x 400	61 / 2.85	2.6	35.2	4228
	1 x 500	61 / 3.20	2.8	38.9	5275
	1 x 630	127 / 2.52	2.8	43.1	6682
	1 x 800	127 / 2.85	2.8	47.6	8407
	1 x 1000	127 / 3.20	3.0	52.9	10535

SINGLE CORE

For current rating and voltage drop, please refer to Table B1.1 and B2.1 on Page 66.

Table 4

PPM

CU / PVC / PVC (2 CORES - 5 CORES)

PVC Insulated, PVC Sheathed Cable, 0.6/1kV, IEC60502

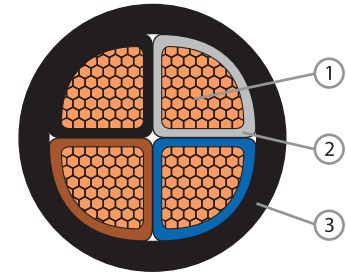

Component
 1. Plain Annealed Copper Wire
 2. PVC Compound
 3. PVC Compound

CONSTRUCTION

Conductor:	Plain Annealed Copper, Class 2 Stranded Circular, Compacted or Sectored
Insulation:	Polyvinyl Chloride (PVC) Compound Type A
Insulation Colour:	2 Cores: Brown, Blue or Red, Black 3 Cores: Brown, Black, Grey or Red, Yellow, Blue 4 Cores: Brown, Black, Grey, Blue or Red, Yellow, Blue, Black 5 Cores: Brown, Black, Grey, Blue, Green/Yellow or Red, Yellow, Blue, Black, Green/Yellow or White with Black numbering or Others
Assembly:	Cores cabled together with filler and covered with Polyester (PET) Tape
Outer Sheath:	Polyvinyl Chloride (PVC) Compound Type ST 1
Outer Sheath Colour:	Black

ELECTRICAL CHARACTERISTICS

Operating Voltage, U ₀ /U:	0.6/1KV
Operating Temperature:	-15°C to 70°C
Final Short Circuit Temperature:	160°C for cable ≤ 300mm ² 140°C for cable >300mm ²
Test Voltage:	3.5kV for 5 minutes

REFERENCE STANDARDS

Design Specification:	IEC60502-1
Conductor:	IEC60228, BS EN60228
Flame Retardancy:	IEC60332-1, BS EN60332-1

INSTALLATION REFERENCE

Min. Bending Radius (mm):	8 x cable overall diameter
Max. Pulling Tension (N/mm ²):	50

	Nominal Conductor Area (mm ²)	No. and Diameter of Wires (no./mm)	Radial Thickness of Insulation (mm)	Cable Overall Diameter (mm)	Approximate Weight (kg/km)
2 CORES	2 x 1.5	7 / 0.53	0.8	10.4	153
	2 x 2.5	7 / 0.67	0.8	11.2	183
	2 x 4	7 / 0.85	1.0	13.3	250
	2 x 6	7 / 1.04	1.0	14.4	304
	2 x 10	7 / 1.35	1.0	16.3	409
	2 x 16	7 / 1.70	1.0	18.4	552
	2 x 25	7 / 2.14	1.2	21.8	789
	2 x 35	7 / 2.52	1.2	24.1	1007
	2 x 50 (S)	19 / 1.78	1.4	24.1	1278
	2 x 70 (S)	19 / 2.14	1.4	26.8	1731
	2 x 95 (S)	19 / 2.52	1.6	30.6	2323
	2 x 120 (S)	37 / 2.03	1.6	33.1	2851
	2 x 150 (S)	37 / 2.25	1.8	36.7	3467
	2 x 185 (S)	37 / 2.52	2.0	40.6	4302
	2 x 240 (S)	61 / 2.25	2.2	45.3	5536
	2 x 300 (S)	61 / 2.52	2.4	50.1	6868

Note: (S) - Sectoral Stranded Conductors.
 # For current rating and voltage drop, please refer to Table B1.2 and B2.2 on Page 67.

Table 5

PPM

CU / PVC / PVC (2 CORES - 5 CORES)

PVC Insulated, PVC Sheathed Cable, 0.6/1kV, IEC60502



	Nominal Conductor Area (mm ²)	No. and Diameter of Wires (no./mm)	Radial Thickness of Insulation (mm)	Cable Overall Diameter (mm)	Approximate Weight (kg/km)
3 CORES	3 x 1.5	7 / 0.53	0.8	10.9	182
	3 x 2.5	7 / 0.67	0.8	11.8	223
	3 x 4	7 / 0.85	1.0	14.1	311
	3 x 6	7 / 1.04	1.0	15.3	388
	3 x 10	7 / 1.35	1.0	17.3	535
	3 x 16	7 / 1.70	1.0	19.6	737
	3 x 25	7 / 2.14	1.2	23.3	1075
	3 x 35	7 / 2.52	1.2	25.7	1389
	3 x 50 (S)	19 / 1.78	1.4	28.3	1825
	3 x 70 (S)	19 / 2.14	1.4	31.7	2491
	3 x 95 (S)	19 / 2.52	1.6	36.4	3378
	3 x 120 (S)	37 / 2.03	1.6	39.5	4158
	3 x 150 (S)	37 / 2.25	1.8	43.8	5064
	3 x 185 (S)	37 / 2.52	2.0	48.5	6292
	3 x 240 (S)	61 / 2.25	2.2	54.5	8144
	3 x 300 (S)	61 / 2.52	2.4	60.1	10086
	3 x 400 (S)	61 / 2.85	2.6	68.2	12800
4 CORES	4 x 1.5	7 / 0.53	0.8	11.8	216
	4 x 2.5	7 / 0.67	0.8	12.8	267
	4 x 4	7 / 0.85	1.0	15.3	379
	4 x 6	7 / 1.04	1.0	16.7	477
	4 x 10	7 / 1.35	1.0	18.9	669
	4 x 16	7 / 1.70	1.0	21.5	932
	4 x 25	7 / 2.14	1.2	25.6	1372
	4 x 35	7 / 2.52	1.2	28.4	1785
	4 x 50 (S)	19 / 1.78	1.4	32.7	2388
	4 x 70 (S)	19 / 2.14	1.4	36.7	3269
	4 x 95 (S)	19 / 2.52	1.6	42.2	4437
	4 x 120 (S)	37 / 2.03	1.6	45.9	5469
	4 x 150 (S)	37 / 2.25	1.8	51.1	6690
	4 x 185 (S)	37 / 2.52	2.0	56.3	8287
	4 x 240 (S)	61 / 2.25	2.2	63.3	10766
	4 x 300 (S)	61 / 2.52	2.4	70.2	13373
	4 x 400 (S)	61 / 2/85	2.6	79.7	16968
4 x 500 (S)	61 / 3.20	2.8	88.0	21161	
5 CORES	5 x 1.5	7 / 0.53	0.8	12.7	250
	5 x 2.5	7 / 0.67	0.8	13.8	313
	5 x 4	7 / 0.85	1.0	16.6	448
	5 x 6	7 / 1.04	1.0	18.2	569
	5 x 10	7 / 1.35	1.0	20.7	804
	5 x 16	7 / 1.70	1.0	23.5	1129
	5 x 25	7 / 2.14	1.2	28.2	1672
	5 x 35	7 / 2.52	1.2	31.4	2198
	5 x 50	19 / 1.78	1.4	36.5	2946
	5 x 70	19 / 2.14	1.4	41.8	4068
	5 x 95	19 / 2.52	1.6	48.2	5506
	5 x 120	37 / 2.03	1.6	52.9	6820
	5 x 150	37 / 2.25	1.8	58.4	8306
	5 x 185	37 / 2.52	2.0	65.0	10331
	5 x 240	61 / 2.25	2.2	73.7	13425
	5 x 300	61 / 2.52	2.4	81.7	16683

Note: (S) - Sectoral Stranded Conductors.
For current rating and voltage drop, please refer to Table B1.2 and B2.2 on Page 67.

PCC

CU / PVC / PVC (MULTI-CORES)

PVC Insulated, PVC Sheathed Cable, 0.6/1kV, BS6346

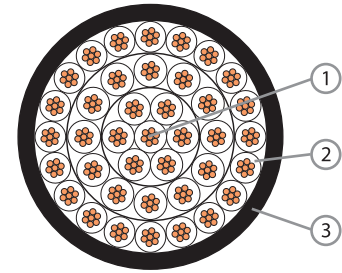
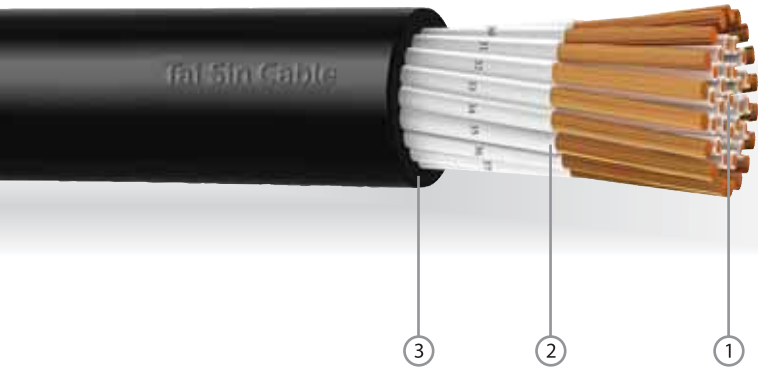

Component
1. Plain Annealed Copper Wire
2. PVC Compound
3. PVC Compound

CONSTRUCTION

Conductor:	Plain Annealed Copper, Class 2 Stranded Circular or Compacted
Insulation:	Polyvinyl Chloride (PVC) Compound Type T11
Insulation Colour:	2 Cores: Brown, Blue or Red, Black 3 Cores: Brown, Black, Grey or Red, Yellow, Blue 4 Cores: Brown, Black, Grey, Blue or Red, Yellow, Blue, Black 5 Cores: Brown, Black, Grey, Blue, Green/Yellow or Red, Yellow, Blue, Black, Green/ Yellow or White with Black numbering or Others 7 Cores & above: White with Black numbering or Others
Assembly:	Cores cabled together and covered with Polyester (PET) Tape
Outer Sheath:	Polyvinyl Chloride (PVC) Compound Type TM 1
Outer Sheath Colour:	Black

ELECTRICAL CHARACTERISTICS

Operating Voltage, U _o /U:	0.6/1KV
Operating Temperature:	-15°C to 70°C
Final Short Circuit Temperature:	160°C
Test Voltage:	3.5kV for 5 minutes

REFERENCE STANDARDS

Design Specification:	BS6346, In-House
Conductor:	IEC60228, BS EN60228
Flame Retardancy:	IEC60332-1, BS EN60332-1

INSTALLATION REFERENCE

Min. Bending Radius (mm):	8 x cable overall diameter
Max. Pulling Tension (N/mm ²):	50

No. of Cores	Nominal Conductor Area (mm ²)	No. and Diameter of Wires (no./mm)	Radial Thickness of Insulation (mm)	Cable Overall Diameter (mm)	Approximate Weight (kg/km)
2	1.5	7 / 0.53	0.6	8.9	129
3		7 / 0.53	0.6	9.3	157
4		7 / 0.53	0.6	10.1	189
5		7 / 0.53	0.6	10.9	221
7		7 / 0.53	0.6	11.9	280
10		7 / 0.53	0.6	15.0	390
12		7 / 0.53	0.6	15.4	441
19		7 / 0.53	0.6	18.1	640
20		7 / 0.53	0.6	19.2	684
24		7 / 0.53	0.6	21.1	801
37		7 / 0.53	0.6	24.2	1149

Note: Other conductor sizes and core configurations are available upon request.
For current rating and voltage drop, please refer to Table B1.2 and B2.2 on Page 67.

Table 7

No. of Cores	Nominal Conductor Area (mm ²)	No. and Diameter of Wires (no./mm)	Radial Thickness of Insulation (mm)	Cable Overall Diameter (mm)	Approximate Weight (kg/km)
2	2.5	7 / 0.67	0.7	10.5	177
3		7 / 0.67	0.7	11.1	219
4		7 / 0.67	0.7	12.0	266
5		7 / 0.67	0.7	13.0	313
7		7 / 0.67	0.7	14.1	399
10		7 / 0.67	0.7	17.6	548
12		7 / 0.67	0.7	18.2	626
19		7 / 0.67	0.7	21.4	918
20		7 / 0.67	0.7	22.7	979
24		7 / 0.67	0.7	25.1	1151
37		7 / 0.67	0.7	28.8	1667
<hr/>					
2	4	7 / 0.85	0.8	12.0	232
3		7 / 0.85	0.8	12.7	294
4		7 / 0.85	0.8	13.8	361
5		7 / 0.85	0.8	15.0	430
7		7 / 0.85	0.8	16.4	556
10		7 / 0.85	0.8	20.8	780
12		7 / 0.85	0.8	21.5	896
19		7 / 0.85	0.8	25.3	1329
20		7 / 0.85	0.8	27.1	1426
24		7 / 0.85	0.8	29.9	1681
37		7 / 0.85	0.8	34.4	2454

Note: Other conductor sizes and core configurations are available upon request.
 # For current rating and voltage drop, please refer to Table B1.2 and B2.2 on Page 67.

Table 8

PAP

CU / PVC / PVC / AWA / PVC (SINGLE CORE)

PVC Insulated, PVC Bedded, Aluminium Wire Armoured, PVC Sheathed Cable, 0.6 / 1kV, BS6346

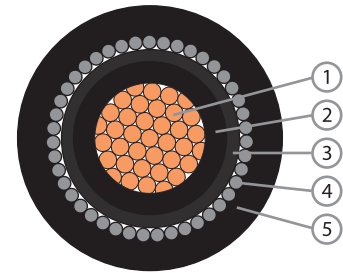

- Component**
1. Plain Annealed Copper Wire
 2. PVC Compound
 3. PVC Compound
 4. Aluminium Wire Armoured
 5. PVC Compound

CONSTRUCTION

Conductor:	Plain Annealed Copper, Class 2 Stranded Circular or Compacted
Insulation:	Polyvinyl Chloride (PVC) Compound Type T11
Insulation Colour:	Black
Bedding:	Polyvinyl Chloride (PVC) Compound Type TM 1
Bedding Colour:	Black
Armour:	Aluminium Wire Armoured (AWA)
Outer Sheath:	Polyvinyl Chloride (PVC) Compound Type TM 1
Outer Sheath Colour:	Black

ELECTRICAL CHARACTERISTICS

Operating Voltage, U ₀ /U:	0.6/1KV
Operating Temperature:	-15°C to 70°C
Final Short Circuit Temperature:	160°C for cable ≤ 300mm ² 140°C for cable >300mm ²
Test Voltage:	3.5kV for 5 minutes

REFERENCE STANDARDS

Design Specification:	BS6346
Conductor:	IEC60228, BS EN60228
Flame Retardancy:	IEC60332-1, BS EN60332-1

INSTALLATION REFERENCE

Min. Bending Radius (mm):	8 x cable overall diameter
Max. Pulling Tension (N/mm ²):	50

	Nominal Conductor Area (mm ²)	No. and Diameter of Wires (no./mm)	Radial Thickness of Insulation (mm)	Diameter Under Armour (mm)	Armour Wire Diameter (mm)	Cable Overall Diameter (mm)	Approximate Weight (kg/km)
SINGLE CORE	1 x 50	19 / 1.78	1.4	13.5	1.25	19.1	169
	1 x 70	19 / 2.14	1.4	15.3	1.25	21.1	1018
	1 x 95	19 / 2.52	1.6	17.6	1.25	23.4	1328
	1 x 120	37 / 2.03	1.6	19.6	1.60	26.3	1686
	1 x 150	37 / 2.25	1.8	21.6	1.60	28.3	2006
	1 x 185	37 / 2.52	2.0	23.8	1.60	30.7	2443
	1 x 240	61 / 2.25	2.2	26.9	1.60	34.0	3101
	1 x 300	61 / 2.52	2.4	29.7	1.60	36.8	3719
	1 x 400	61 / 2.85	2.6	33.5	2.00	41.8	4861
	1 x 500	61 / 3.20	2.8	37.0	2.00	45.3	5956
	1 x 630	127 / 2.52	2.8	41.0	2.00	49.5	7453
	1 x 800	127 / 2.85	2.8	45.7	2.50	55.6	9523
1 x 1000	127 / 3.20	3.0	50.6	2.50	60.7	11749	

For current rating and voltage drop, please refer to Table B1.3 and B2.3 on Page 68.

Table 9

PSP

CU / PVC / PVC / SWA / PVC (2 CORES - 5 CORES)

PVC Insulated, PVC Bedded, Galvanised Steel Wire Armoured, PVC Sheathed Cable, 0.6 / 1kV, BS6346

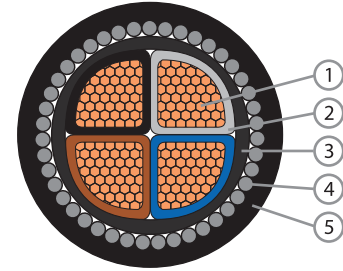
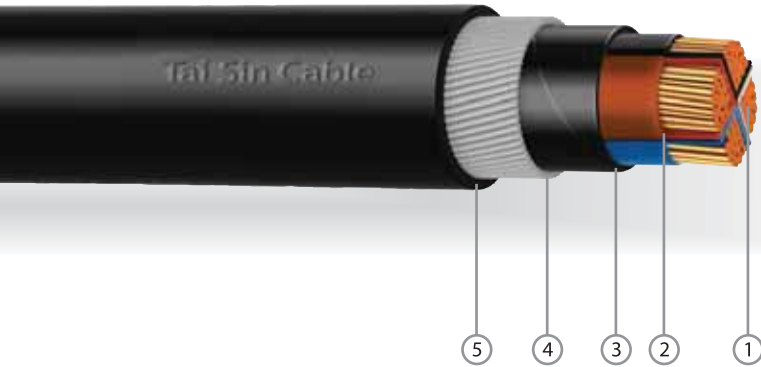

- Component**
1. Plain Annealed Copper Wire
 2. PVC Compound
 3. PVC Compound
 4. Galvanised Steel Wire Armoured
 5. PVC Compound

CONSTRUCTION

Conductor:	Plain Annealed Copper, Class 2 Stranded Circular, Compacted or Sectored
Insulation:	Polyvinyl Chloride (PVC) Compound Type T11
Insulation Colour:	2 Cores: Brown, Blue or Red, Black 3 Cores: Brown, Black, Grey or Red, Yellow, Blue 4 Cores: Brown, Black, Grey, Blue or Red, Yellow, Blue, Black 5 Cores : Brown, Black, Grey, Blue, Green/Yellow or Red, Yellow, Blue, Black, Green/Yellow or White with Black numbering or Others
Assembly:	Cores cabled together with filler and covered with Polyester (PET) Tape
Bedding:	Polyvinyl Chloride (PVC) Compound Type TM 1
Bedding Colour:	Black
Armour:	Galvanized Steel Wire Armoured (SWA)

Outer Sheath: Polyvinyl Chloride (PVC) Compound Type TM 1

Outer Sheath Colour: Black

ELECTRICAL CHARACTERISTICS

Operating Voltage, U ₀ /U:	0.6/1KV
Operating Temperature:	-15°C to 70°C
Final Short Circuit Temperature:	160°C for cable ≤ 300mm ² 140°C for cable >300mm ²
Test Voltage:	3.5kV for 5 minutes

REFERENCE STANDARDS

Design Specification:	BS6346
Conductor:	IEC60228, BS EN60228
Flame Retardancy:	IEC60332-1, BS EN60332-1

INSTALLATION REFERENCE

Min. Bending Radius (mm):	8 x cable overall diameter
Max. Pulling Tension (N/mm ²):	70

	Nominal Conductor Area (mm ²)	No. and Diameter of Wires (no./mm)	Radial Thickness of Insulation (mm)	Diameter Under Armour (mm)	Armour Wire Diameter (mm)	Cable Overall Diameter (mm)	Approximate Weight (kg/km)
2 CORES	2 x 1.5	7 / 0.53	0.6	7.5	0.90	12.3	265
	2 x 2.5	7 / 0.67	0.7	8.7	0.90	13.5	319
	2 x 4	7 / 0.85	0.8	10.2	0.90	15.0	392
	2 x 6	7 / 1.04	0.8	11.3	0.90	16.3	471
	2 x 10	7 / 1.35	1.0	14.0	1.25	19.9	745
	2 x 16	7 / 1.70	1.0	16.1	1.25	22.0	933
	2 x 25	7 / 2.14	1.2	19.9	1.60	26.7	1435
	2 x 35	7 / 2.52	1.2	22.2	1.60	29.2	1730
	2 x 50 (S)	19 / 1.78	1.4	21.2	1.60	28.3	2053
	2 x 70 (S)	19 / 2.14	1.4	24.2	1.60	31.3	2613
	2 x 95 (S)	19 / 2.52	1.6	26.8	2.00	35.1	3527
	2 x 120 (S)	37 / 2.03	1.6	29.6	2.00	38.1	4180
	2 x 150 (S)	37 / 2.25	1.8	32.9	2.00	41.6	4939
	2 x 185 (S)	37 / 2.52	2.0	36.5	2.50	46.4	6271
	2 x 240 (S)	61 / 2.25	2.2	42.2	2.50	52.3	8068
	2 x 300 (S)	61 / 2.52	2.4	46.2	2.50	56.7	8635

Note: (S) - Sectoral Stranded Conductors.
For current rating and voltage drop, please refer to Table B1.4 and B2.4 on Page 69.

Table 10

	Nominal Conductor Area (mm ²)	No. and Diameter of Wires (no./mm)	Radial Thickness of Insulation (mm)	Diameter Under Armour (mm)	Armour Wire Diameter (mm)	Cable Overall Diameter (mm)	Approximate Weight (kg/km)
3 CORES	3 x 1.5	7 / 0.53	0.6	7.9	0.90	12.7	293
	3 x 2.5	7 / 0.67	0.7	9.3	0.90	14.1	363
	3 x 4	7 / 0.85	0.8	10.9	0.90	15.7	454
	3 x 6	7 / 1.04	0.8	12.1	1.25	17.8	644
	3 x 10	7 / 1.35	1.0	15.0	1.25	20.9	884
	3 x 16	7 / 1.70	1.0	17.3	1.25	23.2	1141
	3 x 25	7 / 2.14	1.2	21.4	1.60	28.2	1746
	3 x 35	7 / 2.52	1.2	23.8	1.60	30.8	2155
	3 x 50 (S)	19 / 1.78	1.4	23.8	1.60	31.0	2666
	3 x 70 (S)	19 / 2.14	1.4	27.5	2.00	35.7	3709
	3 x 95 (S)	19 / 2.52	1.6	31.0	2.00	39.4	4710
	3 x 120 (S)	37 / 2.03	1.6	34.0	2.00	42.6	5634
	3 x 150 (S)	37 / 2.25	1.8	38.2	2.50	48.2	7144
	3 x 185 (S)	37 / 2.52	2.0	44.2	2.50	54.4	8894
3 x 240 (S)	61 / 2.25	2.2	49.3	2.50	59.7	11004	
3 x 300 (S)	61 / 2.52	2.4	53.2	2.50	64.0	13182	
3 x 400 (S)	61 / 2.85	2.6	51.7	2.50	72.9	16480	
4 CORES	4 x 1.5	7 / 0.53	0.6	8.7	0.90	13.5	344
	4 x 2.5	7 / 0.67	0.7	10.2	0.90	15.0	416
	4 x 4	7 / 0.85	0.8	12.0	1.25	17.7	629
	4 x 6	7 / 1.04	0.8	13.4	1.25	19.1	752
	4 x 10	7 / 1.35	1.0	16.6	1.25	22.5	1049
	4 x 16	7 / 1.70	1.0	19.5	1.60	26.3	1554
	4 x 25	7 / 2.14	1.2	23.7	1.60	30.7	2131
	4 x 35	7 / 2.52	1.2	26.4	1.60	33.6	2640
	4 x 50 (S)	19 / 1.78	1.4	25.8	2.00	34.0	3474
	4 x 70 (S)	19 / 2.14	1.4	29.8	2.00	38.2	4533
	4 x 95 (S)	19 / 2.52	1.6	33.5	2.00	42.1	5827
	4 x 120 (S)	37 / 2.03	1.6	36.9	2.50	46.9	7407
	4 x 150 (S)	37 / 2.25	1.8	44.0	2.50	54.2	9238
	4 x 185 (S)	37 / 2.52	2.0	48.6	2.50	59.0	11108
4 x 240 (S)	61 / 2.25	2.2	55.5	2.50	66.3	13950	
4 x 300 (S)	61 / 2.52	2.4	61.4	2.50	72.6	16921	
4 x 400 (S)	61 / 2.85	2.6	70.7	3.15	83.3	21961	
5 CORES	5 x 1.5	7 / 0.53	0.6	9.5	0.90	14.3	376
	5 x 2.5	7 / 0.67	0.7	11.2	0.90	16.2	483
	5 x 4	7 / 0.85	0.8	13.2	1.25	18.9	716
	5 x 6	7 / 1.04	0.8	14.7	1.25	20.6	870
	5 x 10	7 / 1.35	1.0	18.7	1.60	25.5	1389
	5 x 16	7 / 1.70	1.0	21.5	1.60	28.3	1810
	5 x 25	7 / 2.14	1.2	26.2	1.60	33.4	2520
	5 x 35	7 / 2.52	1.2	29.3	1.60	37.3	3137
	5 x 50	19 / 1.78	1.4	34.6	2.00	43.0	4377
	5 x 70	19 / 2.14	1.4	39.4	2.00	48.0	5669

Note: (S) - Sectoral Stranded Conductors.
For current rating and voltage drop, please refer to Table B1.4 and B2.4 on Page 69.

PSP

CU / PVC / PVC / SWA / PVC (MULTI-CORES)

PVC Insulated, PVC Bedded, Galvanised Steel Wire Armoured, PVC Sheathed Cable, 0.6 / 1kV, BS6346

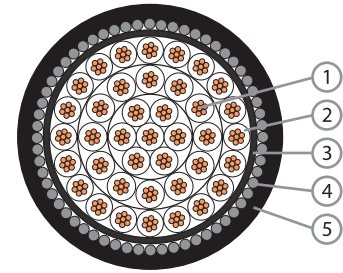
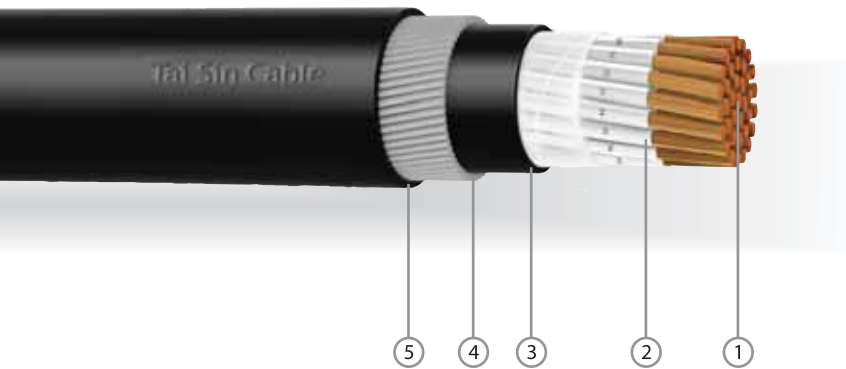

- Component**
1. Plain Annealed Copper Wire
 2. PVC Compound
 3. PVC Compound
 4. Galvanised Steel Wire Armoured
 5. PVC Compound

CONSTRUCTION

Conductor:	Plain Annealed Copper, Class 2 Stranded Circular or Compacted
Insulation:	Polyvinyl Chloride (PVC) Compound Type TI1
Insulation Colour:	White with Black numbering or Others
Assembly:	Cores cabled together and covered with Polyester (PET) Tape
Bedding:	Polyvinyl Chloride (PVC) Compound Type TM 1
Bedding Colour:	Black
Armour:	Galvanised Steel Wire Armoured (SWA)
Outer Sheath:	Polyvinyl Chloride (PVC) Compound Type TM 1
Outer Sheath Colour:	Black

ELECTRICAL CHARACTERISTICS

Operating Voltage, U ₀ /U:	0.6/1KV
Operating Temperature:	-15°C to 70°C
Final Short Circuit Temperature:	160°C
Test Voltage:	3.5kV for 5 minutes

REFERENCE STANDARDS

Design Specification:	BS6346
Conductor:	IEC60228, BS EN60228
Flame Retardancy:	IEC60332-1, BS EN60332-1

INSTALLATION REFERENCE

Min. Bending Radius (mm):	8 x cable overall diameter
Max. Pulling Tension (N/mm ²):	70

No. of Cores	Nominal Conductor Area (mm ²)	No. and Diameter of Wires (no./mm)	Radial Thickness of Insulation (mm)	Diameter Under Armour (mm)	Armour Wire Diameter (mm)	Cable Overall Diameter (mm)	Approximate Weight (kg/km)
5	1.5	7 / 0.53	0.6	9.5	0.9	14.3	390
7		7 / 0.53	0.6	10.4	0.9	15.2	458
10		7 / 0.53	0.6	13.3	1.25	19.0	706
12		7 / 0.53	0.6	13.7	1.25	19.4	763
19		7 / 0.53	0.6	16.2	1.25	22.2	1006
20		7 / 0.53	0.6	17.5	1.6	23.6	1220
24		7 / 0.53	0.6	19.4	1.6	26.2	1399
37		7 / 0.53	0.6	22.3	1.6	29.3	1804

Note: Other conductor sizes and core configurations are available upon request.
For current rating and voltage drop, please refer to Table B1.4 and B2.4 on Page 69.

Table 12

No. of Cores	Nominal Conductor Area (mm ²)	No. and Diameter of Wires (no./mm)	Radial Thickness of Insulation (mm)	Diameter Under Armour (mm)	Armour Wire Diameter (mm)	Cable Overall Diameter (mm)	Approximate Weight (kg/km)
5	2.5	7 / 0.67	0.7	11.2	1.25	16.5	589
7		7 / 0.67	0.7	12.2	1.25	18.2	694
10		7 / 0.67	0.7	15.7	1.25	21.7	920
12		7 / 0.67	0.7	16.3	1.25	22.3	1002
19		7 / 0.67	0.7	19.7	1.6	26.6	1519
20		7 / 0.67	0.7	20.8	1.6	27.9	1612
24		7 / 0.67	0.7	23.2	1.6	30.3	1854
37		7 / 0.67	0.7	26.7	1.6	34.0	2451
MULTI-CORES							
5	4	7 / 0.85	0.8	13.2	1.25	19.2	755
7		7 / 0.85	0.8	14.5	1.25	20.5	903
10		7 / 0.85	0.8	19.5	2.0	26.4	1560
12		7 / 0.85	0.8	20.2	2.0	27.1	1695
19		7 / 0.85	0.8	23.8	2.0	30.9	2261
20		7 / 0.85	0.8	25.2	2.0	32.7	2411
24		7 / 0.85	0.8	28.0	2.0	35.5	2755
37		7 / 0.85	0.8	32.3	2.0	40.8	3674

Note: Other conductor sizes and core configurations are available upon request.
For current rating and voltage drop, please refer to Table B1.4 and B2.4 on Page 69.

Table 13

FLEXI-IMP

(SINGLE CORE, 2 CORES - 4 CORES)

PVC Insulated Flexible Cable, PVC Insulated PVC Sheathed Flexible Cable,
250V / 440V, Imperial Unit BS 2004



CONSTRUCTION

Conductor:	Plain Annealed Copper, Class 5 Stranded Circular
Insulation:	Polyvinyl Chloride (PVC) Compound Type T11
Insulation Colour:	Single Core: Black, Blue, White, Brown, Green, Grey or Others 2 Cores: Blue, Brown 3 Cores: Blue, Brown, Green/Yellow 4 Cores: Blue, Brown, Black, Green/Yellow
Outer Sheath: (For 2, 3, 4 cores only)	Polyvinyl Chloride (PVC) Compound Type T6
Outer Sheath Colour: (For 2, 3, 4 cores only)	Grey

ELECTRICAL CHARACTERISTICS

Operating Voltage, U _o /U:	250/440V
Operating Temperature:	-15°C to 70°C
Final Short Circuit Temperature:	160°C
Test Voltage:	1.5kV for 5 minutes

REFERENCE STANDARDS

Design Specification:	BS2004
Conductor:	BS3360, BS EN60228
Flame Retardancy:	IEC60332-1, BS EN60332-1

INSTALLATION REFERENCE

Min. Bending Radius (mm):	5D for D < 10mm 6D for 10mm ≤ D < 25mm
Max. Pulling Tension (N/mm ²):	15

	Nominal Conductor Area (mm ²)	No. and Diameter of Wire (no./in)	Radial Thickness of Insulation (mm)	Cable Overall Diameter (mm)	Approximate Weight (kg/100yd)
SINGLE CORE	1 x 0.41	14 / 0.0076	0.64	2.4	1.0
	1 x 0.87	23 / 0.0076	0.64	2.7	1.3
	1 x 1.17	40 / 0.0076	0.64	3.0	1.8
	1 x 2.05	70 / 0.0076	0.64	3.5	2.7
	1 x 3.22	110 / 0.0076	0.64	3.9	3.8
	1 x 4.74	162 / 0.0076	0.78	4.8	5.5
2 CORES	2 x 0.41	14 / 0.0076	0.64	6.7	5.1
	2 x 0.87	23 / 0.0076	0.64	7.1	6.0
	2 x 1.17	40 / 0.0076	0.64	7.8	7.7
	2 x 2.05	70 / 0.0076	0.64	9.4	11.5
	2 x 3.22	110 / 0.0076	0.64	10.3	15.0
	2 x 4.74	162 / 0.0076	0.78	11.7	20.5
3 CORES	3 x 0.41	14 / 0.0076	0.64	7.0	5.7
	3 x 0.87	23 / 0.0076	0.64	7.5	7.0
	3 x 1.17	40 / 0.0076	0.64	8.3	9.1
	3 x 2.05	70 / 0.0076	0.64	9.9	13.8
	3 x 3.22	110 / 0.0076	0.64	11.0	18.2
	3 x 4.74	162 / 0.0076	0.78	13.2	26.6
4 CORES	4 x 0.41	14 / 0.0076	0.64	7.6	6.7
	4 x 0.87	23 / 0.0076	0.64	8.1	8.3
	4 x 1.17	40 / 0.0076	0.64	9.7	12.1
	4 x 2.05	70 / 0.0076	0.64	10.7	16.7
	4 x 3.22	110 / 0.0076	0.64	11.9	22.2
	4 x 4.74	162 / 0.0076	0.78	14.0	31.2

Table 14

XP

CU / XLPE / PVC (SINGLE CORE)

XLPE Insulated, PVC Sheathed Cable, 0.6 / 1kV, IEC60502

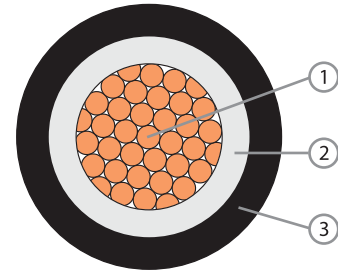

Component
 1. Plain Annealed Copper Wire
 2. Cross-linked Polyethylene Compound
 3. PVC Compound

CONSTRUCTION

Conductor:	Plain Annealed Copper, Class 2 Stranded Circular or Compacted
Insulation:	Cross-linked Polyethylene (XLPE) Compound
Insulation Colour:	Natural
Outer Sheath:	Polyvinyl Chloride (PVC) Compound Type ST2
Outer Sheath Colour:	Black

REFERENCE STANDARDS

Design Specification:	IEC60502-1
Conductor:	IEC60228, BS EN60228
Flame Retardancy:	IEC60332-1, BS EN60332-1

INSTALLATION REFERENCE

Min. Bending Radius (mm):	8 x cable overall diameter
Max. Pulling Tension (N/mm ²):	50

ELECTRICAL CHARACTERISTICS

Operating Voltage, U ₀ /U:	0.6/1KV
Operating Temperature:	-15°C to 90°C
Final Short Circuit Temperature:	250°C
Test Voltage:	3.5kV for 5 minutes

	SINGLE CORE				
	Nominal Conductor Area (mm ²)	No. and Diameter of Wires (no./mm)	Radial Thickness of Insulation (mm)	Cable Overall Diameter (mm)	Approximate Weight (kg/km)
	1 x 16	7 / 1.70	0.7	9.6	225
	1 x 25	7 / 2.14	0.9	11.3	338
	1 x 35	7 / 2.52	0.9	12.5	443
	1 x 50	19 / 1.78	1.0	14.1	582
	1 x 70	19 / 2.14	1.1	16.1	814
	1 x 95	19 / 2.52	1.1	18.2	1097
	1 x 120	37 / 2.03	1.2	20.0	1365
	1 x 150	37 / 2.25	1.4	22.2	1676
	1 x 185	37 / 2.52	1.6	24.4	2081
	1 x 240	61 / 2.25	1.7	27.5	2700
	1 x 300	61 / 2.52	1.8	30.3	3355
	1 x 400	61 / 2.85	2.0	33.9	4262
	1 x 500	61 / 3.20	2.2	37.6	5338
	1 x 630	127 / 2.52	2.4	42.4	6857
	1 x 800	127 / 2.85	2.6	47.3	8701
	1 x 1000	127 / 3.20	2.8	52.4	10891

For current rating and voltage drop, please refer to Table B1.5 and B2.5 on Page 70.

Table 15

XP

CU / XLPE / PVC (2 CORES - 5 CORES)

XLPE Insulated, PVC Sheathed Cable, 0.6 / 1kV, IEC60502

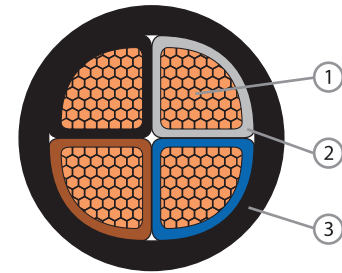

- Component**
1. Plain Annealed Copper Wire
 2. Cross-Linked Polyethylene Compound
 3. PVC Compound

CONSTRUCTION

Conductor:	Plain Annealed Copper, Class 2 Stranded Circular, Compacted or Sectored
Insulation:	Cross-linked Polyethylene (XLPE) Compound
Insulation Colour:	2 Cores: Brown, Blue or Red, Black 3 Cores: Brown, Black, Grey or Red, Yellow, Blue 4 Cores: Brown, Black, Grey, Blue or Red, Yellow, Blue, Black 5 Cores: Brown, Black, Grey, Blue, Green/ Yellow or Red, Yellow, Blue, Black, Green/Yellow or White with Black numbering or Others
Assembly:	Cores cabled together with filler and covered with Polyester (PET) Tape
Outer Sheath:	Polyvinyl Chloride (PVC) Compound Type ST2
Outer Sheath Colour:	Black

ELECTRICAL CHARACTERISTICS

Operating Voltage, U ₀ /U:	0.6/1KV
Operating Temperature:	-15°C to 90°C
Final Short Circuit Temperature:	250°C
Test Voltage:	3.5kV for 5 minutes

REFERENCE STANDARDS

Design Specification:	IEC60502-1
Conductor:	IEC60228, BS EN60228
Flame Retardancy:	IEC60332-1, BS EN60332-1

INSTALLATION REFERENCE

Min. Bending Radius (mm):	8 x cable overall diameter
Max. Pulling Tension (N/mm ²):	50

	Nominal Conductor Area (mm ²)	No. and Diameter of Wires (no./mm)	Radial Thickness of Insulation (mm)	Cable Overall Diameter (mm)	Approximate Weight (kg/km)
	2 x 1.5	7 / 0.53	0.7	10.0	123
	2 x 2.5	7 / 0.67	0.7	10.8	153
	2 x 4	7 / 0.85	0.7	11.9	197
	2 x 6	7 / 1.04	0.7	13.0	252
	2 x 10	7 / 1.35	0.7	14.9	358
	2 x 16	7 / 1.70	0.7	17.0	505
	2 x 25	7 / 2.14	0.9	20.4	754
	2 x 35	7 / 2.52	0.9	22.7	984
2 CORES	2 x 50 (S)	19 / 1.78	1.0	22.4	1237
	2 x 70 (S)	19 / 2.14	1.1	25.4	1711
	2 x 95 (S)	19 / 2.52	1.1	28.2	2287
	2 x 120 (S)	37 / 2.03	1.2	31.2	2856
	2 x 150 (S)	37 / 2.25	1.4	34.9	3523
	2 x 185 (S)	37 / 2.52	1.6	38.1	4387
	2 x 240 (S)	61 / 2.25	1.7	43.2	5678
	2 x 300 (S)	61 / 2.52	1.8	47.4	7028

Note: (S) - Sectoral Stranded Conductors.
For current rating and voltage drop, please refer to Table B1.6 and B2.6 on Page 71.

Table 16

	Nominal Conductor Area (mm ²)	No. and Diameter of Wires (no./mm)	Radial Thickness of Insulation (mm)	Cable Overall Diameter (mm)	Approximate Weight (kg/km)
3 CORES	3 x 1.5	7 / 0.53	0.7	10.5	150
	3 x 2.5	7 / 0.67	0.7	11.4	190
	3 x 4	7 / 0.85	0.7	12.5	252
	3 x 6	7 / 1.04	0.7	13.8	328
	3 x 10	7 / 1.35	0.7	15.8	477
	3 x 16	7 / 1.70	0.7	18.1	684
	3 x 25	7 / 2.14	0.9	21.8	1035
	3 x 35	7 / 2.52	0.9	24.2	1364
	3 x 50 (S)	19 / 1.78	1.0	25.0	1766
	3 x 70 (S)	19 / 2.14	1.1	28.9	2480
	3 x 95 (S)	19 / 2.52	1.1	32.6	3338
	3 x 120 (S)	37 / 2.03	1.2	35.8	4166
	3 x 150 (S)	37 / 2.25	1.4	40.4	5147
	3 x 185 (S)	37 / 2.52	1.6	45.0	6424
	3 x 240 (S)	61 / 2.25	1.7	50.5	8335
	3 x 300 (S)	61 / 2.52	1.8	54.6	10297
	3 x 400 (S)	61 / 2.85	2.0	63.7	13234
	4 CORES	4 x 1.5	7 / 0.53	0.7	11.3
4 x 2.5		7 / 0.67	0.7	12.3	233
4 x 4		7 / 0.85	0.7	13.6	312
4 x 6		7 / 1.04	0.7	15.0	411
4 x 10		7 / 1.35	0.7	17.2	605
4 x 16		7 / 1.70	0.7	19.8	876
4 x 25		7 / 2.14	0.9	23.9	1334
4 x 35		7 / 2.52	0.9	26.7	1766
4 x 50 (S)		19 / 1.78	1.0	27.0	2284
4 x 70 (S)		19 / 2.14	1.1	31.4	3231
4 x 95 (S)		19 / 2.52	1.1	35.3	4354
4 x 120 (S)		37 / 2.03	1.2	39.1	5463
4 x 150 (S)		37 / 2.25	1.4	44.8	6755
4 x 185 (S)		37 / 2.52	1.6	49.8	8446
4 x 240 (S)		61 / 2.25	1.7	57.1	11016
4 x 300 (S)		61 / 2.52	1.8	63.4	13717
4 x 400 (S)		61 / 2.85	2.0	72.8	17558
4 x 500 (S)		61 / 3.20	2.2	80.8	21991
5 CORES	5 x 1.5	7 / 0.53	0.7	12.1	214
	5 x 2.5	7 / 0.67	0.7	13.3	278
	5 x 4	7 / 0.85	0.7	14.7	375
	5 x 6	7 / 1.04	0.7	16.6	496
	5 x 10	7 / 1.35	0.7	18.8	737
	5 x 16	7 / 1.70	0.7	21.6	1072
	5 x 25	7 / 2.14	0.9	26.3	1640
	5 x 35	7 / 2.52	0.9	29.3	2176
	5 x 50	19 / 1.78	1.0	34.2	2849
	5 x 70	19 / 2.14	1.1	40.0	4170
	5 x 95	19 / 2.52	1.1	45.3	5617
	5 x 120	37 / 2.03	1.2	50.6	7056
	5 x 150	37 / 2.25	1.4	56.2	8680
	5 x 185	37 / 2.52	1.6	62.8	10860
	5 x 240	61 / 2.25	1.7	70.8	14093
	5 x 300	61 / 2.52	1.8	78.3	17520

Note: (S) - Sectoral Stranded Conductors.
For current rating and voltage drop, please refer to Table B1.6 and B2.6 on Page 71.

XP

CU / XLPE / PVC (MULTI-CORES)

XLPE Insulated, PVC Sheathed Cable, 0.6 / 1kV, IEC60502

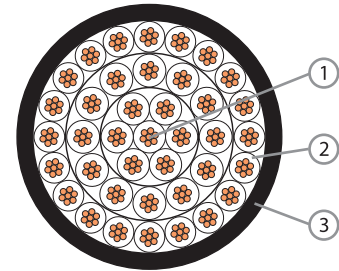
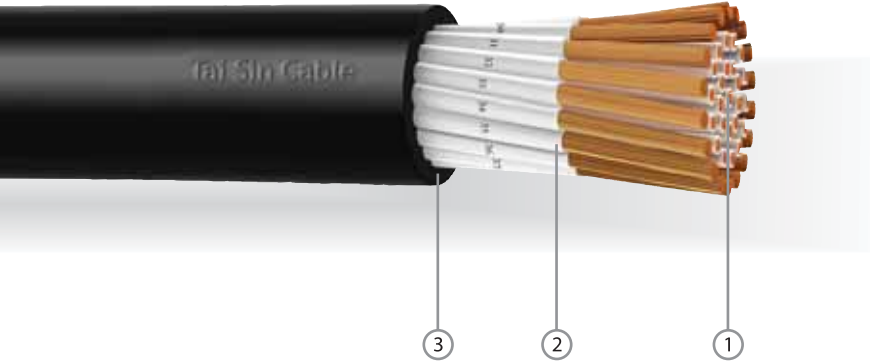

- Component**
1. Plain Annealed Copper Wire
 2. Cross-linked Polyethylene Compound
 3. PVC Compound

CONSTRUCTION

Conductor:	Plain Annealed Copper, Class 2 Stranded Circular or Compacted
Insulation:	Cross-linked Polyethylene (XLPE) Compound
Insulation Colour:	White with Black numbering or Others
Assembly:	Cores cabled together and covered with Polyester (PET) Tape
Outer Sheath:	Polyvinyl Chloride (PVC) Compound Type ST2
Outer Sheath Colour:	Black

ELECTRICAL CHARACTERISTICS

Operating Voltage, U ₀ /U:	0.6/1KV
Operating Temperature:	-15°C to 90°C
Final Short Circuit Temperature:	250°C
Test Voltage:	3.5kV for 5 minutes

REFERENCE STANDARDS

Design Specification:	IEC60502-1
Conductor:	IEC60228, BS EN60228
Flame Retardancy:	IEC60332-1, BS EN60332-1

INSTALLATION REFERENCE

Min. Bending Radius (mm):	8 x cable overall diameter
Max. Pulling Tension (N/mm ²):	50

No. of Cores	Nominal Conductor Area (mm ²)	No. and Diameter of Wires (no./mm)	Radial Thickness of Insulation (mm)	Cable Overall Diameter (mm)	Approximate Weight (kg/km)
5	1.5	7 / 0.53	0.7	12.1	214
7		7 / 0.53	0.7	13.3	278
10		7 / 0.53	0.7	16.4	391
12		7 / 0.53	0.7	16.9	441
19		7 / 0.53	0.7	19.5	635
20		7 / 0.53	0.7	20.5	676
24		7 / 0.53	0.7	22.5	801
37		7 / 0.53	0.7	25.6	1142

Note: Other conductor sizes and core configurations are available upon request.
For current rating and voltage drop, please refer to Table B1.6 and B2.6 on Page 71.

Table 18

XP

CU / XLPE / PVC (MULTI-CORES)

XLPE Insulated, PVC Sheathed Cable, 0.6 / 1kV, IEC60502



No. of Cores	Nominal Conductor Area (mm ²)	No. and Diameter of Wires (no./mm)	Radial Thickness of Insulation (mm)	Cable Overall Diameter (mm)	Approximate Weight (kg/km)
5	2.5	7 / 0.67	0.7	13.3	278
7		7 / 0.67	0.7	14.5	364
10		7 / 0.67	0.7	18.0	574
12		7 / 0.67	0.7	18.6	586
19		7 / 0.67	0.7	21.6	856
20		7 / 0.67	0.7	22.7	910
24		7 / 0.67	0.7	25.1	1082
37		7 / 0.67	0.7	28.6	1560
<hr/>					
5	4	7 / 0.85	0.7	14.7	375
7		7 / 0.85	0.7	16.2	496
10		7 / 0.85	0.7	20.2	705
12		7 / 0.85	0.7	20.8	809
19		7 / 0.85	0.7	24.3	1199
20		7 / 0.85	0.7	25.6	1273
24		7 / 0.85	0.7	28.3	1519
37		7 / 0.85	0.7	32.6	2229

Note: Other conductor sizes and core configurations are available upon request.
 # For current rating and voltage drop, please refer to Table B1.6 and B2.6 on Page 71.

Table 19

XAP

CU / XLPE / PVC / AWA / PVC (SINGLE CORE)

XLPE Insulated, PVC Bedded, Aluminium Wire Armoured, PVC Sheathed Cable, 0.6 / 1kV, IEC60502

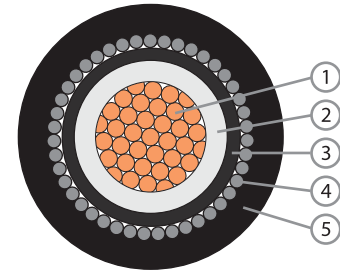
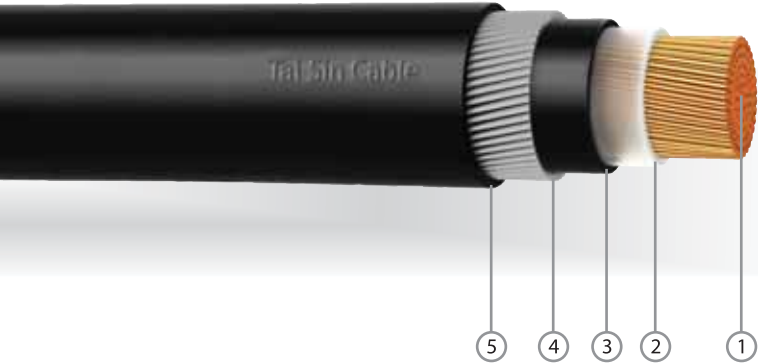

- Component**
1. Plain Annealed Copper Wire
 2. Cross-linked Polyethylene Compound
 3. PVC Compound
 4. Aluminium Wire Armoured
 5. PVC Compound

CONSTRUCTION

Conductor:	Plain Annealed Copper, Class 2 Stranded Circular or Compacted
Insulation:	Cross-linked Polyethylene (XLPE) Compound
Insulation Colour:	Natural
Bedding:	Polyvinyl Chloride (PVC) Compound Type ST2
Bedding Colour:	Black
Armour:	Aluminium Wire Armoured (AWA)
Outer Sheath:	Polyvinyl Chloride (PVC) Compound Type ST2
Outer Sheath Colour:	Black

ELECTRICAL CHARACTERISTICS

Operating Voltage, U ₀ /U:	0.6/1KV
Operating Temperature:	-15°C to 90°C
Final Short Circuit Temperature:	250°C
Test Voltage:	3.5kV for 5 minutes

REFERENCE STANDARDS

Design Specification:	IEC60502-1
Conductor:	IEC60228, BS EN60228
Flame Retardancy:	IEC60332-1, BS EN60332-1

INSTALLATION REFERENCE

Min. Bending Radius (mm):	8 x cable overall diameter
Max. Pulling Tension (N/mm ²):	50

	Nominal Conductor Area (mm ²)	No. and Diameter of Wires (no./mm)	Radial Thickness of Insulation (mm)	Diameter Under Armour (mm)	Armour Wire Diameter (mm)	Cable Overall Diameter (mm)	Approximate Weight (kg/km)
SINGLE CORE	1 x 50	19 / 1.78	1.0	13.2	1.25	19.5	897
	1 x 70	19 / 2.14	1.1	15.2	1.25	21.5	1150
	1 x 95	19 / 2.52	1.1	17.1	1.25	23.4	1444
	1 x 120	37 / 2.03	1.2	18.9	1.6	25.9	1787
	1 x 150	37 / 2.25	1.4	20.9	1.6	27.9	2105
	1 x 185	37 / 2.52	1.6	23.1	1.6	30.1	2535
	1 x 240	61 / 2.25	1.7	26.0	1.6	33.2	3178
	1 x 300	61 / 2.52	1.8	28.6	1.6	35.8	3840
	1 x 400	61 / 2.85	2.0	32.4	2.0	40.8	4921
	1 x 500	61 / 3.20	2.2	35.9	2.0	44.5	6029
	1 x 630	127 / 2.52	2.4	40.3	2.0	49.1	7551
	1 x 800	127 / 2.85	2.6	45.4	2.5	55.6	9646
	1 x 1000	127 / 3.20	2.8	50.3	2.5	60.9	11897

For current rating and voltage drop, please refer to Table B1.7 and B2.7 on Page 72.

Table 20

XSP

CU / XLPE / PVC / SWA / PVC (2 CORES - 5 CORES)

XLPE Insulated, PVC Bedded, Galvanised Steel Wire Armoured, PVC Sheathed Cable, 0.6 / 1kV, IEC60502

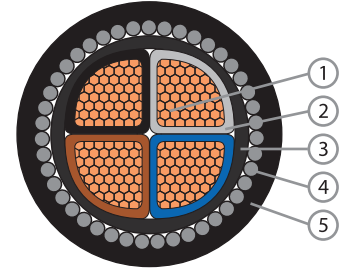
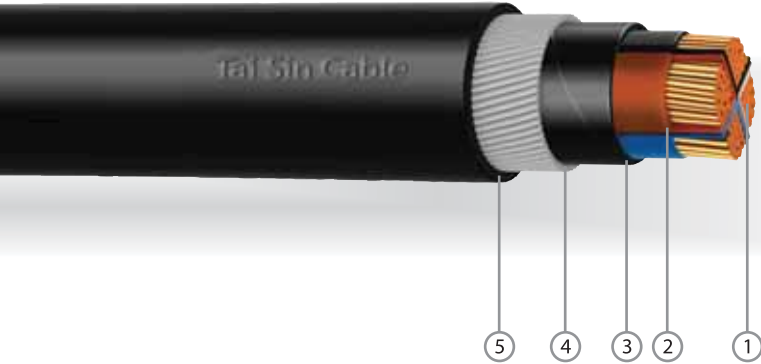

- Component**
1. Plain Annealed Copper Wire
 2. Cross-linked Polyethylene Compound
 3. PVC Compound
 4. Galvanised Steel Wire Armoured
 5. PVC Compound

CONSTRUCTION

Conductor:	Plain Annealed Copper, Class 2 Stranded Circular, Compacted or Sectored
Insulation:	Cross-linked Polyethylene (XLPE) Compound
Insulation Colour:	2 Cores: Brown, Blue or Red, Black 3 Cores: Brown, Black, Grey or Red, Yellow, Blue 4 Cores: Brown, Black, Grey, Blue or Red, Yellow, Blue, Black 5 Cores: Brown, Black, Grey, Blue, Green/Yellow or Red, Yellow, Blue, Black, Green/Yellow or White with Black numbering or Others
Assembly:	Cores cabled together with filler and covered with Polyester (PET) Tape
Bedding:	Polyvinyl Chloride (PVC) Compound Type ST2 or ST2 PVC Tape
Bedding Colour:	Black
Armour:	Galvanized Steel Wire Armoured (SWA)

Outer Sheath: Polyvinyl Chloride (PVC) Compound Type ST2

Outer Sheath Colour: Black

ELECTRICAL CHARACTERISTICS

Operating Voltage, U ₀ /U:	0.6/1kV
Operating Temperature:	-15°C to 90°C
Final Short Circuit Temperature:	250°C
Test Voltage:	3.5kV for 5 minutes

REFERENCE STANDARDS

Design Specification:	IEC60502-1
Conductor:	IEC60228, BS EN60228
Flame Retardancy:	IEC60332-1, BS EN60332-1

INSTALLATION REFERENCE

Min. Bending Radius (mm):	8 x cable overall diameter
Max. Pulling Tension (N/mm ²):	70

	Nominal Conductor Area (mm ²)	No. and Diameter of Wires (no./mm)	Radial Thickness of Insulation (mm)	Diameter Under Armour (mm)	Armour Wire Diameter (mm)	Cable Overall Diameter (mm)	Approximate Weight (kg/km)
2 CORES	2 x 1.5	7 / 0.53	0.7	8.3	0.9	13.9	445
	2 x 2.5	7 / 0.67	0.7	9.1	0.9	14.7	498
	2 x 4	7 / 0.85	0.7	10.2	0.9	15.8	573
	2 x 6	7 / 1.04	0.7	11.3	0.9	16.9	658
	2 x 10	7 / 1.35	0.7	13.2	1.25	19.5	913
	2 x 16	7 / 1.70	0.7	15.3	1.25	21.6	1122
	2 x 25	7 / 2.14	0.9	18.7	1.6	25.7	1603
	2 x 35	7 / 2.52	0.9	21.0	1.6	28.0	1921
	2 x 50 (S)	19 / 1.78	1.0	21.2	1.6	28.3	2132
	2 x 70 (S)	19 / 2.14	1.1	24.2	2.0	31.7	2736
	2 x 95 (S)	19 / 2.52	1.1	26.8	2.0	35.3	3626
	2 x 120 (S)	37 / 2.03	1.2	29.6	2.0	38.3	4295
	2 x 150 (S)	37 / 2.25	1.4	32.9	2.0	41.8	5065
	2 x 185 (S)	37 / 2.52	1.6	36.5	2.5	46.8	6434
	2 x 240 (S)	61 / 2.25	1.7	42.2	2.5	52.9	8259
	2 x 300 (S)	61 / 2.52	1.8	46.2	2.5	57.1	9793

Note: (S) - Sectoral Stranded Conductors.
For current rating and voltage drop, please refer to Table B1.8 and B2.8 on Page 73.

Table 21

	Nominal Conductor Area (mm ²)	No. and Diameter of Wires (no./mm)	Radial Thickness of Insulation (mm)	Diameter Under Armour (mm)	Armour Wire Diameter (mm)	Cable Overall Diameter (mm)	Approximate Weight (kg/km)
3 CORES	3 x 1.5	7 / 0.53	0.7	8.8	0.9	14.4	487
	3 x 2.5	7 / 0.67	0.7	9.7	0.9	15.3	551
	3 x 4	7 / 0.85	0.7	10.8	0.9	16.4	643
	3 x 6	7 / 1.04	0.7	12.1	0.9	17.7	755
	3 x 10	7 / 1.35	0.7	14.1	1.25	20.4	1057
	3 x 16	7 / 1.70	0.7	16.4	1.25	22.7	1337
	3 x 25	7 / 2.14	0.9	20.1	1.6	27.1	1937
	3 x 35	7 / 2.52	0.9	22.5	1.6	29.5	2353
	3 x 50 (S)	19 / 1.78	1.0	23.8	1.6	31.1	2759
	3 x 70 (S)	19 / 2.14	1.1	27.5	2.0	35.8	3827
	3 x 95 (S)	19 / 2.52	1.1	31.0	2.0	39.7	4825
	3 x 120 (S)	37 / 2.03	1.2	34.0	2.0	42.9	5771
	3 x 150 (S)	37 / 2.25	1.4	38.2	2.5	48.5	7301
	3 x 185 (S)	37 / 2.52	1.6	42.6	2.5	53.1	8741
	3 x 240 (S)	61 / 2.25	1.7	49.3	2.5	60.2	11198
3 x 300 (S)	61 / 2.52	1.8	53.2	2.5	64.5	13357	
3 x 400 (S)	61 / 2.85	2.0	61.7	2.5	73.4	16606	
4 CORES	4 x 1.5	7 / 0.53	0.7	9.6	0.9	15.2	541
	4 x 2.5	7 / 0.67	0.7	10.6	0.9	16.2	617
	4 x 4	7 / 0.85	0.7	11.9	0.9	17.5	733
	4 x 6	7 / 1.04	0.7	13.3	1.25	19.6	966
	4 x 10	7 / 1.35	0.7	15.5	1.25	21.8	1234
	4 x 16	7 / 1.70	0.7	18.1	1.6	25.1	1706
	4 x 25	7 / 2.14	0.9	22.2	1.6	29.2	2306
	4 x 35	7 / 2.52	0.9	25.0	1.6	32.2	2855
	4 x 50 (S)	19 / 1.78	1.0	25.8	1.6	33.3	3359
	4 x 70 (S)	19 / 2.14	1.1	29.8	2.0	38.5	4671
	4 x 95 (S)	19 / 2.52	1.1	33.5	2.0	42.4	5935
	4 x 120 (S)	37 / 2.03	1.2	36.9	2.5	47.2	7546
	4 x 150 (S)	37 / 2.25	1.4	44.0	2.5	54.5	9404
	4 x 185 (S)	37 / 2.52	1.6	48.6	2.5	59.5	11315
	4 x 240 (S)	61 / 2.25	1.7	55.5	2.5	66.8	14144
4 x 300 (S)	61 / 2.52	1.8	61.4	2.5	73.1	17092	
4 x 400 (S)	61 / 2.85	2.0	70.2	3.15	83.8	22157	
5 CORES	5 x 1.5	7 / 0.53	0.7	10.4	0.9	16.0	597
	5 x 2.5	7 / 0.67	0.7	11.6	0.9	17.2	690
	5 x 4	7 / 0.85	0.7	13.0	1.25	19.3	918
	5 x 6	7 / 1.04	0.7	14.6	1.25	20.9	1089
	5 x 10	7 / 1.35	0.7	17.1	1.25	23.4	1403
	5 x 16	7 / 1.70	0.7	19.9	1.6	26.9	1973
	5 x 25	7 / 2.14	0.9	24.6	1.6	31.6	2695
	5 x 35	7 / 2.52	0.9	27.6	1.6	34.8	3345
	5 x 50	19 / 1.78	1.0	32.8	2.0	41.3	4502
	5 x 70	19 / 2.14	1.1	38.2	2.0	47.1	5901
	5 x 95	19 / 2.52	1.1	43.3	2.5	53.4	7632
	5 x 120	37 / 2.03	1.2	48.2	2.5	58.7	9585
	5 x 150	37 / 2.25	1.4	55.0	2.5	65.9	11807
	5 x 185	37 / 2.52	1.6	61.2	2.5	72.5	14193
	5 x 240	61 / 2.25	1.7	68.6	2.5	80.5	17700

Note: (S) - Sectoral Stranded Conductors.
For current rating and voltage drop, please refer to Table B1.8 and B2.8 on Page 73.

XSP

CU / XLPE / PVC / SWA / PVC (MULTI-CORES)

XLPE Insulated, PVC Bedded, Galvanised Steel Wire Armoured, PVC Sheathed Cable, 0.6 / 1kV, IEC60502

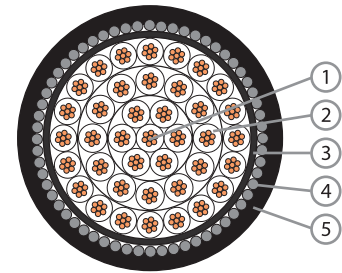
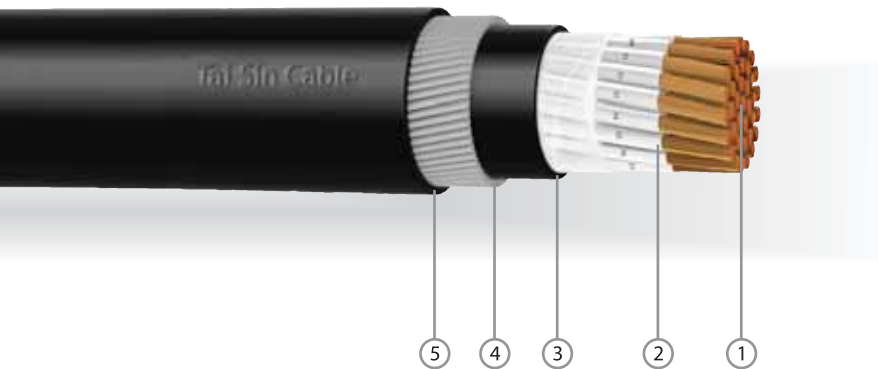

- Component**
1. Plain Annealed Copper Wire
 2. Cross-linked Polyethylene Compound
 3. PVC Compound
 4. Galvanised Steel Wire Armoured
 5. PVC Compound

CONSTRUCTION

Conductor:	Plain Annealed Copper, Class 2 Stranded Circular or Compacted
Insulation:	Cross-linked Polyethylene (XLPE) Compound
Insulation Colour:	White with Black numbering or Others
Assembly:	Cores cabled together and covered with Polyester (PET) Tape
Bedding:	Polyvinyl Chloride (PVC) Compound Type ST2
Bedding Colour:	Black
Armour:	Galvanized Steel Wire Armoured (SWA)
Outer Sheath:	Polyvinyl Chloride (PVC) Compound Type ST2
Outer Sheath Colour:	Black

ELECTRICAL CHARACTERISTICS

Operating Voltage, U _o /U:	0.6/1kV
Operating Temperature:	-15°C to 90°C
Final Short Circuit Temperature:	250°C
Test Voltage:	3.5kV for 5 minutes

REFERENCE STANDARDS

Design Specification:	IEC60502-1
Conductor:	IEC60228, BS EN60228
Flame Retardancy:	IEC60332-1, BS EN60332-1

INSTALLATION REFERENCE

Min. Bending Radius (mm):	8 x cable overall diameter
Max. Pulling Tension (N/mm ²):	70

No. of Cores	Nominal Conductor Area (mm ²)	No. and Diameter of Wires (no./mm)	Radial Thickness of Insulation (mm)	Diameter Under Armour (mm)	Armour Wire Diameter (mm)	Cable Overall Diameter (mm)	Approximate Weight (kg/km)
5	1.5	7 / 0.53	0.7	10.4	0.9	16.0	597
7		7 / 0.53	0.7	11.6	0.9	17.2	692
10		7 / 0.53	0.7	14.7	1.25	21.0	986
12		7 / 0.53	0.7	15.2	1.25	21.5	1059
19		7 / 0.53	0.7	17.8	1.25	24.1	1326
20		7 / 0.53	0.7	18.8	1.6	25.8	1527
24		7 / 0.53	0.7	20.8	1.6	27.8	1724
37		7 / 0.53	0.7	23.9	1.6	30.9	2167

Note: Other conductor sizes and core configurations are available upon request.
For current rating and voltage drop, please refer to Table B1.8 and B2.8 on Page 73.

Table 23

XSP

CU / XLPE / PVC / SWA / PVC (MULTI-CORES)

XLPE Insulated, PVC Bedded, Galvanised Steel Wire Armoured, PVC Sheathed Cable,
0.6 / 1kV, IEC60502



No. of Cores	Nominal Conductor Area (mm ²)	No. and Diameter of Wires (no./mm)	Radial Thickness of Insulation (mm)	Diameter Under Armour (mm)	Armour Wire Diameter (mm)	Cable Overall Diameter (mm)	Approximate Weight (kg/km)
5	2.5	7 / 0.67	0.7	11.6	0.9	17.2	690
7		7 / 0.67	0.7	12.8	1.25	19.1	907
10		7 / 0.67	0.7	16.3	1.25	22.6	1169
12		7 / 0.67	0.7	16.9	1.25	23.2	1253
19		7 / 0.67	0.7	19.9	1.6	26.9	1743
20		7 / 0.67	0.7	21.0	1.6	28.0	1849
24		7 / 0.67	0.7	23.4	1.6	30.4	2090
37		7 / 0.67	0.7	26.9	1.6	34.1	2700
MULTI-CORES							
5	4	7 / 0.85	0.7	13.0	1.25	19.3	918
7		7 / 0.85	0.7	14.5	1.25	20.8	1090
10		7 / 0.85	0.7	18.5	1.6	25.5	1555
12		7 / 0.85	0.7	19.1	1.6	26.1	1678
19		7 / 0.85	0.7	22.6	1.6	29.6	2189
20		7 / 0.85	0.7	23.9	1.6	30.9	2298
24		7 / 0.85	0.7	26.6	1.6	33.8	2659
37		7 / 0.85	0.7	31.1	2.0	39.5	3807

Note: Other conductor sizes and core configurations are available upon request.
For current rating and voltage drop, please refer to Table B1.8 and B2.8 on Page 73.

Table 24

XCP

CU / XLPE / PVC / CT / PVC (3 CORES + 3 EARTH)

XLPE Insulated, PVC Bedded, Copper Tape Screened, PVC Sheathed Cable, 0.6 / 1kV, IEC60502

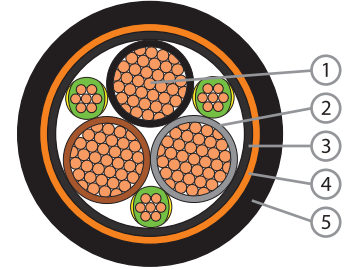
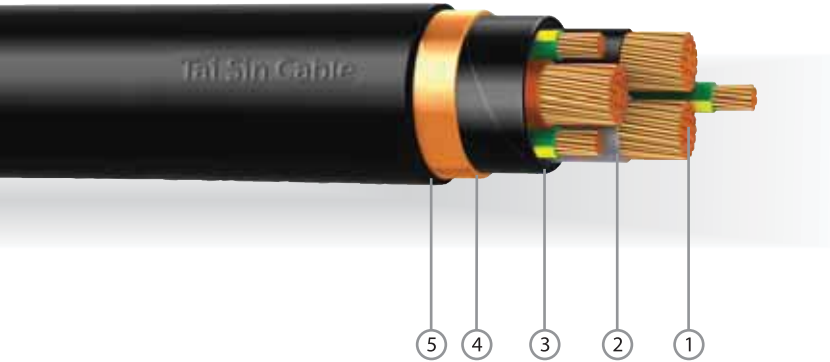

- Component**
1. Plain Annealed Copper Wire
 2. Cross-linked Polyethylene Compound
 3. PVC Compound
 4. Copper Tape
 5. PVC Compound

CONSTRUCTION

Conductor:	Plain Annealed Copper, Class 2 Stranded Circular or Compacted
Insulation:	Cross-linked Polyethylene (XLPE) Compound
Insulation Colour:	Brown, Black, Grey, Green/Yellow (x3) or Red, Yellow, Blue, Green/Yellow (x3) or Others
Assembly:	Cores cabled together with filler and covered with Polyester (PET) Tape
Bedding:	Polyvinyl Chloride (PVC) Compound Type ST2
Bedding Colour:	Black
Screen:	Copper Tape
Outer Sheath:	Polyvinyl Chloride (PVC) Compound Type ST2
Outer Sheath Colour:	Black

ELECTRICAL CHARACTERISTICS

Operating Voltage, U ₀ /U:	0.6/1kV
Operating Temperature:	-15°C to 90°C
Final Short Circuit Temperature:	250°C
Test Voltage:	3.5kV for 5 minutes

REFERENCE STANDARDS

Design Specification:	IEC60502-1
Conductor:	IEC60228, BS EN60228
Flame Retardancy:	IEC60332-1, BS EN60332-1

INSTALLATION REFERENCE

Min. Bending Radius (mm):	8 x cable overall diameter
Max. Pulling Tension (N/mm ²):	50

	Nominal Conductor Area (mm ²)	Combined Earth Size (mm ²)	No. and Diameter of Wires (no./mm)	Radial Thickness of Insulation (mm)	Diameter Under Screen (mm)	Cable Overall Diameter (mm)	Approximate Weight (kg/km)
3 CORES + 3 EARTH	3 x 1.5	4.5 (3 x 1.5)	7 / 0.53	0.7	11.7	16.8	490
	3 x 2.5	4.5 (3 x 1.5)	7 / 0.67	0.7	12.3	17.4	537
	3 x 4	4.5 (3 x 1.5)	7 / 0.85	0.7	13.1	18.2	606
	3 x 6	7.5 (3 x 2.5)	7 / 1.04	0.7	14.6	19.7	736
	3 x 10	12 (3 x 4)	7 / 1.35	0.7	16.8	21.9	964
	3 x 16	18 (3 x 6)	7 / 1.70	0.7	19.2	24.3	1263
	3 x 25	30 (3 x 10)	7 / 2.14	0.9	23.2	28.3	1782
	3 x 35	30 (3 x 10)	7 / 2.52	0.9	24.9	30.0	2111
	3 x 50	30 (3 x 10)	19 / 1.78	1.0	27.4	32.5	2554
	3 x 70	48 (3 x 16)	19 / 2.14	1.1	32.4	37.9	3544
	3 x 95	48 (3 x 16)	19 / 2.52	1.1	35.2	41.3	4569
	3 x 120	75 (3 x 25)	37 / 2.03	1.2	40.5	46.8	5791
	3 x 150	75 (3 x 25)	37 / 2.25	1.4	43.8	50.3	6785
	3 x 185	105 (3 x 35)	37 / 2.52	1.6	49.0	55.9	8415
	3 x 240	150 (3 x 50)	61 / 2.25	1.7	56.0	63.3	10837
	3 x 300	150 (3 x 50)	61 / 2.52	1.8	60.0	67.9	13082

For current rating and voltage drop, please refer to Table B1.6 and B2.6 on Page 71.

Table 25

XCP

CU / XLPE / PVC / CT / PVC (4 CORES)

XLPE Insulated, PVC Bedded, Copper Tape Screened, PVC Sheathed Cable, 0.6 / 1kV, IEC60502

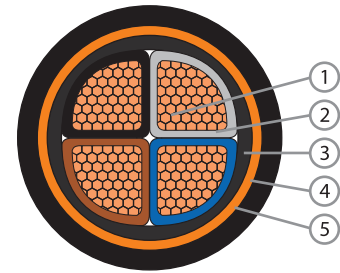
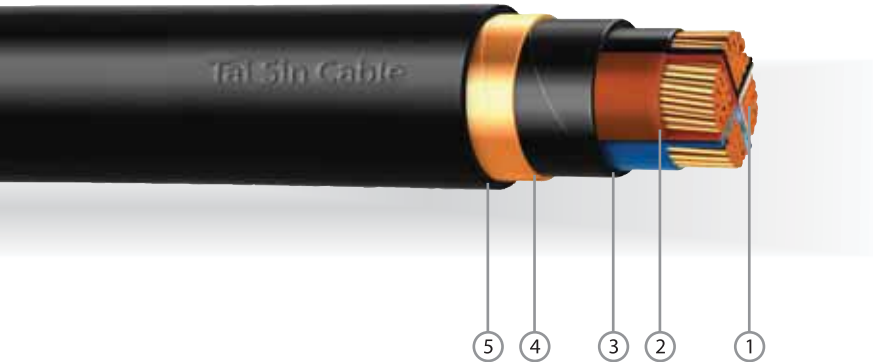

- Component**
1. Plain Annealed Copper Wire
 2. Cross-linked Polyethylene Compound
 3. PVC Compound
 4. Copper Tape
 5. PVC Compound

CONSTRUCTION

Conductor:	Plain Annealed Copper, Class 2 Stranded Circular, Compacted or Sectored
Insulation:	Cross-linked Polyethylene (XLPE) Compound
Insulation Colour:	Brown, Black, Grey, Blue or Red, Yellow, Blue, Black or Others
Assembly:	Cores cabled together with filler and covered with Polyester (PET) Tape
Bedding:	Polyvinyl Chloride (PVC) Compound Type ST2
Bedding Colour:	Black
Screen:	Copper Tape
Outer Sheath:	Polyvinyl Chloride (PVC) Compound Type ST2
Outer Sheath Colour:	Black

ELECTRICAL CHARACTERISTICS

Operating Voltage, U ₀ /U:	0.6/1kV
Operating Temperature:	-15°C to 90°C
Final Short Circuit Temperature:	250°C
Test Voltage:	3.5kV for 5 minutes

REFERENCE STANDARDS

Design Specification:	IEC60502-1
Conductor:	IEC60228, BS EN60228
Flame Retardancy:	IEC60332-1, BS EN60332-1

INSTALLATION REFERENCE

Min. Bending Radius (mm):	8 x cable overall diameter
Max. Pulling Tension (N/mm ²):	50

	Nominal Conductor Area (mm ²)	No. and Diameter of Wires (no./mm)	Radial Thickness of Insulation (mm)	Diameter Under Screen (mm)	Cable Overall Diameter (mm)	Approximate Weight (kg/km)
	4 x 1.5	7 / 0.53	0.7	9.7	14.1	392
	4 x 2.5	7 / 0.67	0.7	10.7	15.1	460
	4 x 4	7 / 0.85	0.7	12.0	16.4	559
	4 x 6	7 / 1.04	0.7	13.4	17.8	679
	4 x 10	7 / 1.35	0.7	15.6	20.0	905
	4 x 16	7 / 1.70	0.7	18.2	22.6	1207
	4 x 25	7 / 2.14	0.9	22.3	26.7	1721
	4 x 35	7 / 2.52	0.9	25.1	29.5	2178
	4 x 50 (S)	19 / 1.78	1.0	25.4	30.0	2736
	4 x 70 (S)	19 / 2.14	1.1	29.8	34.6	3748
	4 x 95 (S)	19 / 2.52	1.1	33.5	39.1	5047
	4 x 120 (S)	37 / 2.03	1.2	37.3	43.1	6256
	4 x 150 (S)	37 / 2.25	1.4	42.8	49.0	7634
	4 x 185 (S)	37 / 2.52	1.6	47.4	53.8	9361
	4 x 240 (S)	61 / 2.25	1.7	54.7	61.5	12023
	4 x 300 (S)	61 / 2.52	1.8	60.6	68.2	15025

Note: (S) - Sectoral Stranded Conductors.
For current rating and voltage drop, please refer to Table B1.6 and B2.6 on Page 71.

Table 26

XCAP

CU / XLPE / PVC / CT / PVC / AWA / PVC (SINGLE CORE)

XLPE Insulated, PVC Bedded, Copper Tape Screened, PVC Separation Sheath, Aluminium Wire Armoured, PVC Sheathed Cable, 0.6 / 1kV, IEC60502

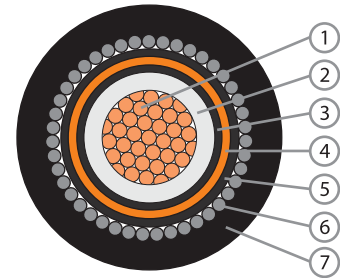

- Component**
1. Plain Annealed Copper Wire
 2. Cross-linked Polyethylene Compound
 3. PVC Compound
 4. Copper Tape
 5. PVC Compound
 6. Aluminium Wire Armoured
 7. PVC Compound

CONSTRUCTION

Conductor:	Plain Annealed Copper, Class 2 Stranded Circular or Compacted
Insulation:	Cross-linked Polyethylene (XLPE) Compound
Insulation Colour:	Natural
Bedding:	Polyvinyl Chloride (PVC) Compound Type ST2
Bedding Colour:	Black
Screen:	Copper Tape
Separation Sheath:	Polyvinyl Chloride (PVC) Compound Type ST2
Separation Sheath Colour:	Black
Armour:	Aluminium Wire Armoured (AWA)
Outer Sheath:	Polyvinyl Chloride (PVC) Compound Type ST2
Outer Sheath Colour:	Black

ELECTRICAL CHARACTERISTICS

Operating Voltage, U ₀ /U:	0.6/1kV
Operating Temperature:	-15°C to 90°C
Final Short Circuit Temperature:	250°C
Test Voltage:	3.5kV for 5 minutes

REFERENCE STANDARDS

Design Specification:	IEC60502-1
Conductor:	IEC60228, BS EN60228
Flame Retardancy:	IEC60332-1, BS EN60332-1

INSTALLATION REFERENCE

Min. Bending Radius (mm):	8 x cable overall diameter
Max. Pulling Tension (N/mm ²):	50

	Nominal Conductor Area (mm ²)	No. and Diameter of Wires (no./mm)	Radial Thickness of Insulation (mm)	Diameter Under Screen (mm)	Diameter Under Armour (mm)	Armour Wire Diameter (mm)	Cable Overall Diameter (mm)	Approximate Weight (kg/km)
SINGLE CORE	1 x 70	19 / 2.14	1.1	15.2	18.7	1.6	25.7	1655
	1 x 95	19 / 2.52	1.1	17.2	20.6	1.6	27.6	2010
	1 x 120	37 / 2.03	1.2	19.0	22.4	1.6	29.4	2352
	1 x 150	37 / 2.25	1.4	21.0	24.6	1.6	31.6	2829
	1 x 185	37 / 2.52	1.6	23.2	26.8	1.6	34.0	3344
	1 x 240	61 / 2.25	1.7	26.1	29.7	2.0	37.9	4174
	1 x 300	61 / 2.52	1.8	28.7	32.3	2.0	40.7	5141
	1 x 400	61 / 2.85	2.0	32.5	36.1	2.0	44.7	6271
	1 x 500	61 / 3.20	2.2	36.0	39.6	2.0	48.4	7527
	1 x 630	127 / 2.52	2.4	40.4	44.2	2.5	54.4	9446
	1 x 800	127 / 2.85	2.6	45.5	49.5	2.5	59.9	11625
	1 x 1000	127 / 3.20	2.8	50.4	54.6	2.5	65.4	14114

For current rating and voltage drop, please refer to Table B1.7 and B2.7 on Page 72.

Table 27

XCSP

CU / XLPE / PVC / CT / PVC / SWA / PVC (4 CORES)

XLPE Insulated, PVC Bedded, Copper Tape Screened, PVC Separation Sheath, Galvanised Steel Wire Armoured, PVC Sheathed Cable, 0.6 / 1kV, IEC60502

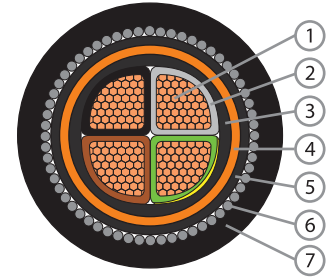
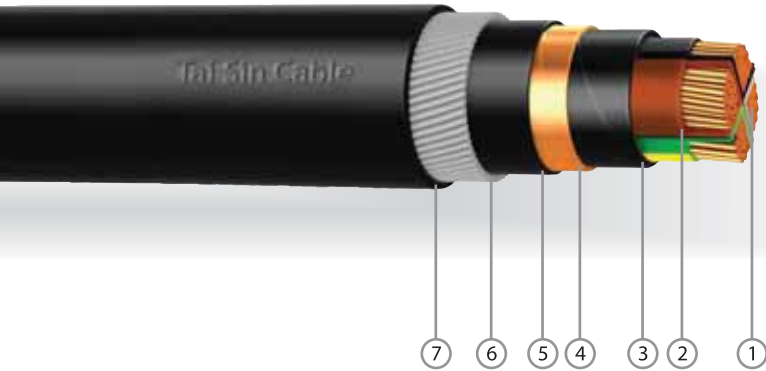

- Component**
1. Plain Annealed Copper Wire
 2. Cross-linked Polyethylene Compound
 3. PVC Compound
 4. Copper Tape
 5. PVC Compound
 6. Galvanised Steel Wire Armoured
 7. PVC Compound

CONSTRUCTION

Conductor:	Plain Annealed Copper, Class 2 Stranded Circular, Compacted or Sectored
Insulation:	Cross-linked Polyethylene (XLPE) Compound
Insulation Colour:	Brown, Black, Grey, Green/Yellow or Red, Yellow, Blue, Green/Yellow or Others
Assembly:	Cores cabled together with filler and covered with Polyester (PET) Tape
Bedding:	Polyvinyl Chloride (PVC) Compound Type ST2
Bedding Colour:	Black
Screen:	Copper Tape
Separation Sheath:	Polyvinyl Chloride (PVC) Compound Type ST2
Separation Sheath Colour:	Black
Armour:	Galvanized Steel Wire Armoured (SWA)
Outer Sheath:	Polyvinyl Chloride (PVC) Compound Type ST2
Outer Sheath Colour:	Black

ELECTRICAL CHARACTERISTICS

Operating Voltage, U ₀ /U:	0.6/1kV
Operating Temperature:	-15°C to 90°C
Final Short Circuit Temperature:	250°C
Test Voltage:	3.5kV for 5 minutes

REFERENCE STANDARDS

Design Specification:	IEC60502-1
Conductor:	IEC60228, BS EN60228
Flame Retardancy:	IEC60332-1, BS EN60332-1

INSTALLATION REFERENCE

Min. Bending Radius (mm):	8 x cable overall diameter
Max. Pulling Tension (N/mm ²):	70

	Nominal Conductor Area (mm ²)	No. and Diameter of Wires (no./mm)	Radial Thickness of Insulation (mm)	Armour Wire Diameter (mm)	Cable Overall Diameter (mm)	Approximate Weight (kg/km)
4 CORES	4 x 1.5	7 / 0.53	0.7	1.25	19.5	880
	4 x 2.5	7 / 0.67	0.7	1.25	20.5	986
	4 x 4	7 / 0.85	0.7	1.25	21.8	1126
	4 x 6	7 / 1.04	0.7	1.25	23.2	1296
	4 x 10	7 / 1.35	0.7	1.60	26.1	1732
	4 x 16	7 / 1.70	0.7	1.60	28.7	2136
	4 x 25	7 / 2.14	0.9	1.60	33.0	2818
	4 x 35	7 / 2.52	0.9	1.60	36.0	3394
	4 x 50 (S)	19 / 1.78	1.0	2.00	37.3	4186
	4 x 70 (S)	19 / 2.14	1.1	2.00	42.1	5421
	4 x 95 (S)	19 / 2.52	1.1	2.50	47.6	7336
	4 x 120 (S)	37 / 2.03	1.2	2.50	52.0	8782
	4 x 150 (S)	37 / 2.25	1.4	2.50	58.1	10495
	4 x 185 (S)	37 / 2.52	1.6	2.50	62.9	12467
	4 x 240 (S)	61 / 2.25	1.7	2.50	71.0	15599
	4 x 300 (S)	61 / 2.52	1.8	3.15	79.0	19597

Note: (S) - Sectoral Stranded Conductors.
For current rating and voltage drop, please refer to Table B1.8 and B2.8 on Page 73.

FRT-H

CU / LSZH (SINGLE CORE)

Cross-Linked Polyolefin LSZH Insulated, Non-Sheathed Cable, 450 / 750V (0.6 / 1kV*), BS7211

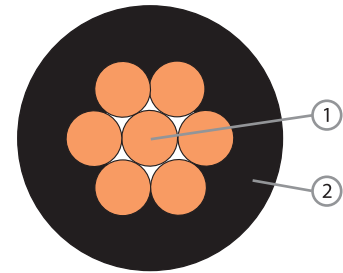
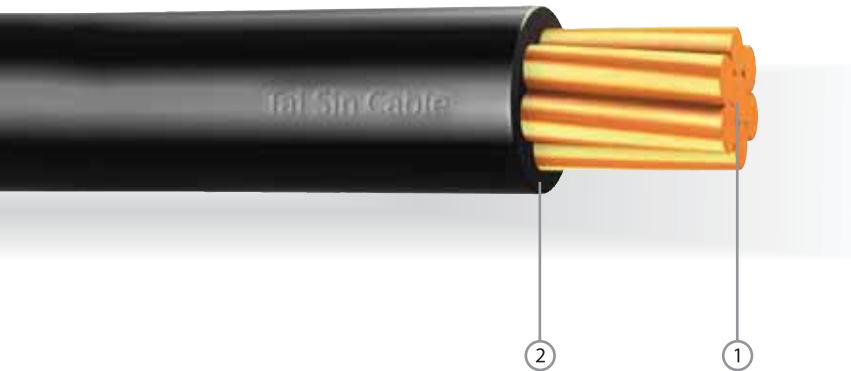

- Component**
1. Plain Annealed Copper Wire
 2. Cross-linked Polyolefin Low Smoke Zero Halogen Compound

CONSTRUCTION

Conductor:	Plain Annealed Copper, Class 2 Stranded Circular or Compacted
Insulation:	Cross-linked Polyolefin (LSZH) Low Smoke Zero Halogen Compound
Insulation Colour:	Black, Green/Yellow, Red, Yellow, Blue, White, Brown, Grey or Others

REFERENCE STANDARDS

Design Specification:	BS7211
Conductor:	IEC60228, BS EN60228
Flame Retardancy:	IEC60332-3-22, BS EN60332-3-22
Low Smoke Zero Halogen:	IEC61034-2, BS EN61034-2 IEC60754-1, IEC60754-2 BS EN50267-2-1, BS EN50267-2-2

ELECTRICAL CHARACTERISTICS

Operating Voltage:	450 / 750V (0.6/1kV*)
Operating Temperature:	-15°C to 90°C
Final Short Circuit Temperature:	250°C
Test Voltage:	3.5kV for 5 minutes

INSTALLATION REFERENCE

Min. Bending Radius (mm):	6 x cable overall diameter
Max. Pulling Tension (N/mm ²):	50

	SINGLE CORE				
	Nominal Conductor Area (mm ²)	No. and Diameter of Wires (no./mm)	Radial Thickness of Insulation (mm)	Cable Overall Diameter (mm)	Approximate Weight (kg/km)
	1 x 1.5	7 / 0.53	0.7	3.1	25
	1 x 2.5	7 / 0.67	0.8	3.7	37
	1 x 4	7 / 0.85	0.8	4.3	53
	1 x 6	7 / 1.04	0.8	4.8	73
	1 x 10	7 / 1.35	1.0	6.2	121
	1 x 16	7 / 1.70	1.0	7.2	180
	1 x 25	7 / 2.14	1.2	9.0	283
	1 x 35	7 / 2.52	1.2	10.2	379
	1 x 50	19 / 1.78	1.4	11.9	513
	1 x 70	19 / 2.14	1.4	13.7	716
	1 x 95	19 / 2.52	1.6	16.0	987
	1 x 120	37 / 2.03	1.6	17.6	1227
	1 x 150	37 / 2.25	1.8	19.6	1509
	1 x 185	37 / 2.52	2.0	21.8	1889
	1 x 240	61 / 2.25	2.2	24.9	2468
	1 x 300	61 / 2.52	2.4	27.7	3084
	1 x 400	61 / 2.85	2.6	31.1	3923
	1 x 500	61 / 3.20	2.8	34.6	4920
	1 x 630	127 / 2.52	2.8	38.6	6269

Note: For FRT-H cables, Cross-Linked LSZH Compound will be used as the insulation material.
For current rating and voltage drop, please refer to Table B1.5 and B2.5 on Page 70.
* Condition apply.

Table 30

FRT-XH

CU / XLPE / LSZH (SINGLE CORE)

XLPE Insulated, LSZH Sheathed Cable, 0.6 / 1kV, IEC60502

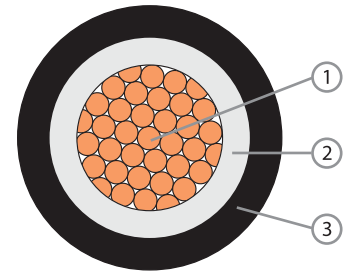

Component
 1. Plain Annealed Copper Wire
 2. Cross-linked Polyethylene Compound
 3. Low Smoke Zero Halogen (LSZH) Compound

CONSTRUCTION

Conductor:	Plain Annealed Copper, Class 2 Stranded Circular or Compacted
Insulation:	Cross-linked Polyethylene (XLPE) Compound
Insulation Colour:	Natural
Outer Sheath:	Low Smoke Zero Halogen (LSZH) Compound
Outer Sheath Colour:	Black

REFERENCE STANDARDS

Design Specification:	IEC60502-1
Conductor:	IEC60228, BS EN60228
Flame Retardancy:	IEC60332-3-22, BS EN60332-3-22
Low Smoke Zero Halogen:	IEC61034-2, BS EN61034-2 IEC60754-1, IEC60754-2 BS EN50267-2-1, BS EN50267-2-2

ELECTRICAL CHARACTERISTICS

Operating Voltage:	0.6/1kV
Operating Temperature:	-15°C to 90°C
Final Short Circuit Temperature:	250°C
Test Voltage:	3.5kV for 5 minutes

INSTALLATION REFERENCE

Min. Bending Radius (mm):	8 x cable overall diameter
Max. Pulling Tension (N/mm ²):	50

	Nominal Conductor Area (mm ²)	No. and Diameter of Wires (no./mm)	Radial Thickness of Insulation (mm)	Cable Overall Diameter (mm)	Approximate Weight (kg/km)
	1 x 1.5	7 / 0.53	0.7	6.1	75
	1 x 2.5	7 / 0.67	0.7	6.5	89
	1 x 4	7 / 0.85	0.7	7.1	110
	1 x 6	7 / 1.04	0.7	7.6	136
	1 x 10	7 / 1.35	0.7	8.6	186
	1 x 16	7 / 1.70	0.7	9.6	254
	1 x 25	7 / 2.14	0.9	11.3	367
	1 x 35	7 / 2.52	0.9	12.5	472
	1 x 50	19 / 1.78	1.0	14.1	612
	1 x 70	19 / 2.14	1.1	16.1	837
	1 x 95	19 / 2.52	1.1	18.2	1114
	1 x 120	37 / 2.03	1.2	20.0	1374
	1 x 150	37 / 2.25	1.4	22.2	1675
	1 x 185	37 / 2.52	1.6	24.4	2066
	1 x 240	61 / 2.25	1.7	27.5	2661
	1 x 300	61 / 2.52	1.8	30.3	3291
	1 x 400	61 / 2.85	2.0	33.9	4159
	1 x 500	61 / 3.20	2.2	37.6	5188
	1 x 630	127 / 2.52	2.4	42.4	6638
	1 x 800	127 / 2.85	2.6	47.3	8394
	1 x 1000	127 / 3.20	2.8	52.4	10479

SINGLE CORE

For current rating and voltage drop, please refer to Table B1.5 and B2.5 on Page 70.

Table 31

FRT-XH

CU / XLPE / LSZH (2 CORES - 5 CORES)

XLPE Insulated, LSZH Sheathed Cable, 0.6 / 1kV, IEC60502

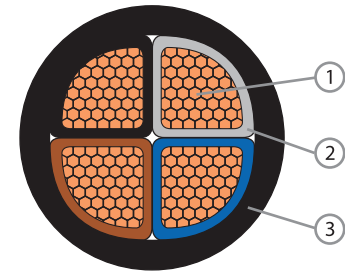
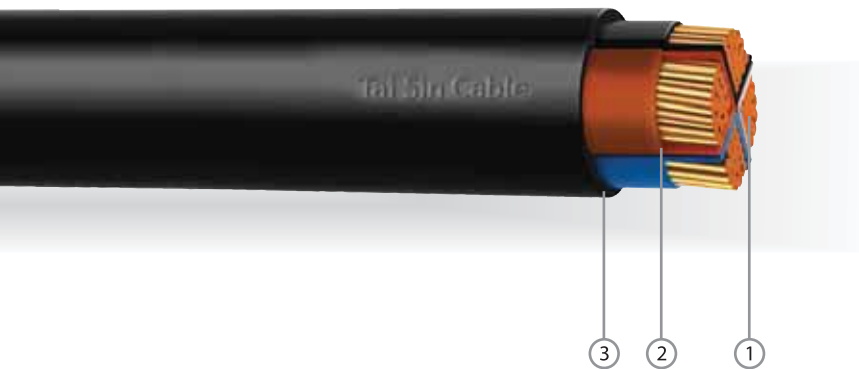

Component
 1. Plain Annealed Copper Wire
 2. Cross-linked Polyethylene Compound
 3. Low Smoke Zero Halogen (LSZH) Compound

CONSTRUCTION

Conductor:	Plain Annealed Copper, Class 2 Stranded Circular, Compacted or Sectored
Insulation:	Cross-linked Polyethylene (XLPE) Compound
Insulation Colour:	2 Cores: Brown, Blue or Red, Black 3 Cores: Brown, Black, Grey or Red, Yellow, Blue 4 Cores: Brown, Black, Grey, Blue or Red, Yellow, Blue, Black 5 Cores: Brown, Black, Grey, Blue, Green/Yellow or Red, Yellow, Blue, Black, Green/Yellow or White with Black numbering or Others
Assembly:	Cores cabled together with filler and covered with Polyester (PET) Tape
Outer Sheath:	Low Smoke Zero Halogen (LSZH) Compound
Outer Sheath Colour:	Black

ELECTRICAL CHARACTERISTICS

Operating Voltage:	0.6/1kV
Operating Temperature:	-15°C to 90°C
Final Short Circuit Temperature:	250°C
Test Voltage:	3.5kV for 5 minutes

REFERENCE STANDARDS

Design Specification:	IEC60502-1
Conductor:	IEC60228, BS EN60228
Flame Retardancy:	IEC60332-3-22, BS EN60332-3-22
Low Smoke Zero Halogen:	IEC61034-2, BS EN61034-2 IEC60754-1, IEC60754-2 BS EN50267-2-1, BS EN50267-2-2

INSTALLATION REFERENCE

Min. Bending Radius (mm):	8 x cable overall diameter
Max. Pulling Tension (N/mm ²):	50

	Nominal Conductor Area (mm ²)	No. and Diameter of Wires (no./mm)	Radial Thickness of Insulation (mm)	Cable Overall Diameter (mm)	Approximate Weight (kg/km)
	2 x 1.5	7 / 0.53	0.7	10.0	137
	2 x 2.5	7 / 0.67	0.7	10.8	170
	2 x 4	7 / 0.85	0.7	11.9	220
	2 x 6	7 / 1.04	0.7	13.0	280
	2 x 10	7 / 1.35	0.7	14.9	399
	2 x 16	7 / 1.70	0.7	17.0	561
	2 x 25	7 / 2.14	0.9	20.4	841
	2 x 35	7 / 2.52	0.9	22.7	1096
2 CORES	2 x 50 (S)	19 / 1.78	1.0	22.4	1240
	2 x 70 (S)	19 / 2.14	1.1	25.4	1694
	2 x 95 (S)	19 / 2.52	1.1	28.2	2248
	2 x 120 (S)	37 / 2.03	1.2	31.2	2782
	2 x 150 (S)	37 / 2.25	1.4	34.9	3418
	2 x 185 (S)	37 / 2.52	1.6	38.7	4233
	2 x 240 (S)	61 / 2.25	1.7	43.2	5458
	2 x 300 (S)	61 / 2.52	1.8	47.4	6736

Note: (S) - Sectoral Stranded Conductors.
 # For current rating and voltage drop, please refer to Table B1.6 and B2.6 on Page 71.

Table 32

FRT-XH

CU / XLPE / LSZH (2 CORES - 5 CORES)

XLPE Insulated, LSZH Sheathed Cable, 0.6 / 1kV, IEC60502



	Nominal Conductor Area (mm ²)	No. and Diameter of Wires (no./mm)	Radial Thickness of Insulation (mm)	Cable Overall Diameter (mm)	Approximate Weight (kg/km)
3 CORES	3 x 1.5	7 / 0.53	0.7	10.5	159
	3 x 2.5	7 / 0.67	0.7	11.4	201
	3 x 4	7 / 0.85	0.7	12.5	265
	3 x 6	7 / 1.04	0.7	13.8	344
	3 x 10	7 / 1.35	0.7	15.8	500
	3 x 16	7 / 1.70	0.7	18.1	715
	3 x 25	7 / 2.14	0.9	21.8	1082
	3 x 35	7 / 2.52	0.9	24.2	1424
	3 x 50 (S)	19 / 1.78	1.0	25.0	1751
	3 x 70 (S)	19 / 2.14	1.1	28.9	2434
	3 x 95 (S)	19 / 2.52	1.1	32.6	3256
	3 x 120 (S)	37 / 2.03	1.2	35.8	4047
	3 x 150 (S)	37 / 2.25	1.4	40.4	4967
	3 x 185 (S)	37 / 2.52	1.6	45.0	6169
	3 x 240 (S)	61 / 2.25	1.7	50.5	7978
	3 x 300 (S)	61 / 2.52	1.8	54.6	9852
	3 x 400 (S)	61 / 2.85	2.0	63.7	12567
4 CORES	4 x 1.5	7 / 0.53	0.7	11.3	189
	4 x 2.5	7 / 0.67	0.7	12.3	242
	4 x 4	7 / 0.85	0.7	13.6	323
	4 x 6	7 / 1.04	0.7	15.0	425
	4 x 10	7 / 1.35	0.7	17.2	624
	4 x 16	7 / 1.70	0.7	19.8	901
	4 x 25	7 / 2.14	0.9	23.9	1373
	4 x 35	7 / 2.52	0.9	26.7	1815
	4 x 50 (S)	19 / 1.78	1.0	27.0	2254
	4 x 70 (S)	19 / 2.14	1.1	31.4	3162
	4 x 95 (S)	19 / 2.52	1.1	35.3	4241
	4 x 120 (S)	37 / 2.03	1.2	39.1	5302
	4 x 150 (S)	37 / 2.25	1.4	44.8	6503
	4 x 185 (S)	37 / 2.52	1.6	49.8	8104
	4 x 240 (S)	61 / 2.25	1.7	57.1	10515
	4 x 300 (S)	61 / 2.52	1.8	63.4	13058
	4 x 400 (S)	61 / 2.85	2.0	72.8	16625
4 x 500 (S)	61 / 3.20	2.2	80.8	20785	
5 CORES	5 x 1.5	7 / 0.53	0.7	12.1	223
	5 x 2.5	7 / 0.67	0.7	13.3	288
	5 x 4	7 / 0.85	0.7	14.7	388
	5 x 6	7 / 1.04	0.7	16.3	512
	5 x 10	7 / 1.35	0.7	18.8	759
	5 x 16	7 / 1.70	0.7	21.6	1102
	5 x 25	7 / 2.14	0.9	26.3	1685
	5 x 35	7 / 2.52	0.9	29.3	2234
	5 x 50	19 / 1.78	1.0	34.2	2845
	5 x 70	19 / 2.14	1.1	40.0	3989
	5 x 95	19 / 2.52	1.1	45.3	5348
	5 x 120	37 / 2.03	1.2	50.6	6689

Note: (S) - Sectoral Stranded Conductors.
For current rating and voltage drop, please refer to Table B1.6 and B2.6 on Page 71.

Table 33

FRT-XH

CU / XLPE / LSZH (MULTI-CORES)

XLPE Insulated, LSZH Sheathed Cable, 0.6 / 1kV, IEC60502

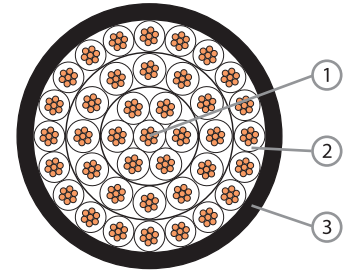
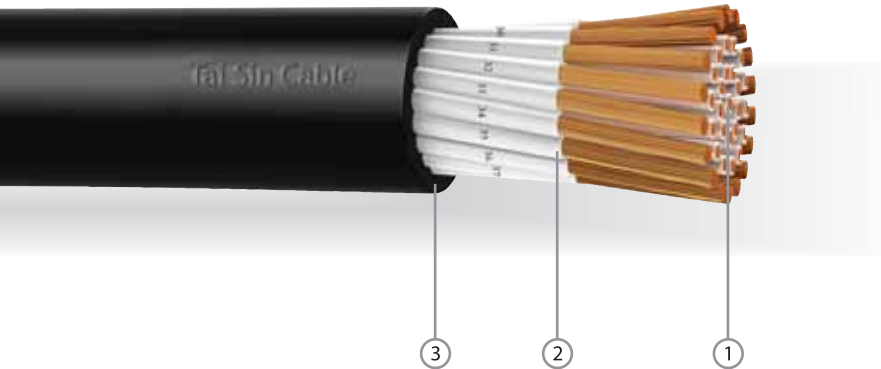

- Component**
1. Plain Annealed Copper Wire
 2. Cross-linked Polyethylene Compound
 3. Low Smoke Zero Halogen (LSZH) Compound

CONSTRUCTION

Conductor:	Plain Annealed Copper, Class 2 Stranded Circular or Compacted
Insulation:	Cross-linked Polyethylene (XLPE) Compound
Insulation Colour:	White with Black numbering or Others
Assembly:	Cores cabled together and covered with Polyester (PET) Tape
Outer Sheath:	Low Smoke Zero Halogen (LSZH) Compound
Outer Sheath Colour:	Black

ELECTRICAL CHARACTERISTICS

Operating Voltage:	0.6/1kV
Operating Temperature:	-15°C to 90°C
Final Short Circuit Temperature:	250°C
Test Voltage:	3.5kV for 5 minutes

REFERENCE STANDARDS

Design Specification:	IEC60502-1
Conductor:	IEC60228, BS EN60228
Flame Retardancy:	IEC60332-3-22, BS EN60332-3-22
Low Smoke Zero Halogen:	IEC61034-2, BS EN61034-2 IEC60754-1, IEC60754-2 BS EN50267-2-1, BS EN50267-2-2

INSTALLATION REFERENCE

Min. Bending Radius (mm):	8 x cable overall diameter
Max. Pulling Tension (N/mm ²):	50

No. of Cores	Nominal Conductor Area (mm ²)	No. and Diameter of Wires (no./mm)	Radial Thickness of Insulation (mm)	Cable Overall Diameter (mm)	Approximate Weight (kg/km)
5	1.5	7 / 0.53	0.7	12.1	223
7		7 / 0.53	0.7	13.1	309
10		7 / 0.53	0.7	16.2	417
12		7 / 0.53	0.7	16.7	467
19		7 / 0.53	0.7	19.3	652
20		7 / 0.53	0.7	20.3	688
24		7 / 0.53	0.7	22.3	803
37		7 / 0.53	0.7	25.4	1122

Note : Other conductor sizes & core configurations are available upon request.
For current rating and voltage drop, please refer to Table B1.6 and B2.6 on Page 71.

Table 34

FRT-XH

CU / XLPE / LSZH (**MULTI-CORES**)

XLPE Insulated, LSZH Sheathed Cable, 0.6 / 1kV, IEC60502



No. of Cores	Nominal Conductor Area (mm ²)	No. and Diameter of Wires (no./mm)	Radial Thickness of Insulation (mm)	Cable Overall Diameter (mm)	Approximate Weight (kg/km)
5	2.5	7 / 0.67	0.7	13.3	288
7		7 / 0.67	0.7	14.3	394
10		7 / 0.67	0.7	17.8	536
12		7 / 0.67	0.7	18.4	606
19		7 / 0.67	0.7	21.4	863
20		7 / 0.67	0.7	22.5	910
24		7 / 0.67	0.7	24.9	1067
37		7 / 0.67	0.7	28.4	1515
<hr/>					
5	4	7 / 0.85	0.7	14.7	388
7		7 / 0.85	0.7	16.0	523
10		7 / 0.85	0.7	20.0	719
12		7 / 0.85	0.7	20.6	820
19		7 / 0.85	0.7	24.1	1189
20		7 / 0.85	0.7	25.4	1254
24		7 / 0.85	0.7	28.1	1476
37		7 / 0.85	0.7	32.4	2145

Note : Other conductor sizes & core configurations are available upon request.
 # For current rating and voltage drop, please refer to Table B1.6 and B2.6 on Page 71.

Table 35

FRT-XAH

CU / XLPE / LSZH / AWA / LSZH (SINGLE CORE)

XLPE Insulated, LSZH Bedded, Aluminium Wire Armoured, LSZH Sheathed Cable, 0.6 / 1kV, BS6724

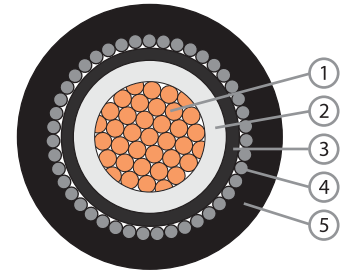
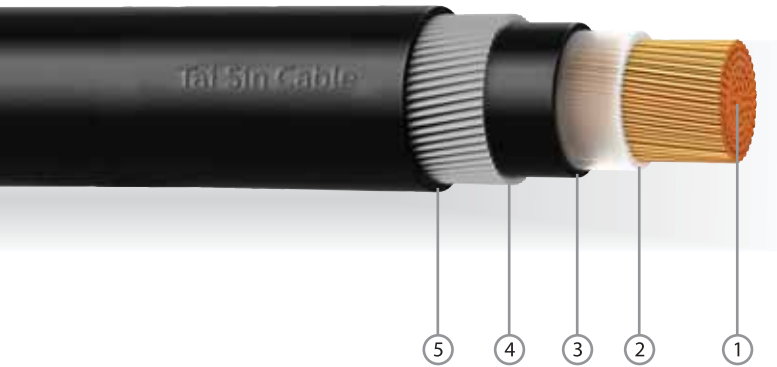

- Component**
1. Plain Annealed Copper Wire
 2. Cross-linked Polyethylene Compound
 3. Low Smoke Zero Halogen (LSZH) Compound
 4. Aluminium Wire Armoured
 5. Low Smoke Zero Halogen (LSZH) Compound

CONSTRUCTION

Conductor:	Plain Annealed Copper, Class 2 Stranded Circular or Compacted
Insulation:	Cross-linked Polyethylene (XLPE) Compound
Insulation Colour:	Natural
Bedding:	Low Smoke Zero Halogen (LSZH) Compound
Bedding Colour:	Black
Armour:	Aluminium Wire Armoured (AWA)
Outer Sheath:	Low Smoke Zero Halogen (LSZH) Compound
Outer Sheath Colour:	Black

ELECTRICAL CHARACTERISTICS

Operating Voltage:	0.6/1kV
Operating Temperature:	-15°C to 90°C
Final Short Circuit Temperature:	250°C
Test Voltage:	3.5kV for 5 minutes

REFERENCE STANDARDS

Design Specification:	BS6724
Conductor:	IEC60228, BS EN60228
Flame Retardancy:	IEC60332-3-22, BS EN60332-3-22
Low Smoke Zero Halogen:	IEC61034-2, BS EN61034-2 IEC60754-1, IEC60754-2 BS EN50267-2-1, BS EN50267-2-2

INSTALLATION REFERENCE

Min. Bending Radius (mm):	8 x cable overall diameter
Max. Pulling Tension (N/mm ²):	50

	Nominal Conductor Area (mm ²)	No. and Diameter of Wires (no./mm)	Diameter Under Armour (mm)	Armour Wire Diameter (mm)	Cable Overall Diameter (mm)	Approximate Weight (kg/km)
SINGLE CORE	1 x 50	19 / 1.78	12.9	1.25	18.6	932
	1 x 70	19 / 2.14	14.9	1.25	20.6	1149
	1 x 95	19 / 2.52	16.8	1.25	22.7	1463
	1 x 120	37 / 2.03	18.6	1.25	25.2	1762
	1 x 150	37 / 2.25	21.0	1.6	27.8	2181
	1 x 185	37 / 2.52	23.2	1.6	30.2	2633
	1 x 240	61 / 2.25	26.1	1.6	33.1	3279
	1 x 300	61 / 2.52	28.7	1.6	35.9	3966
	1 x 400	61 / 2.85	32.5	2.0	40.7	5044
	1 x 500	61 / 3.20	36.0	2.0	44.4	6168
	1 x 630	127 / 2.52	40.4	2.0	49.0	7711
	1 x 800	127 / 2.85	45.5	2.5	55.5	9840
	1 x 1000	127 / 3.20	50.4	2.5	60.6	12071

For current rating and voltage drop, please refer to Table B1.7 and B2.7 on Page 72.

Table 36

FRT-XSH

CU / XLPE / LSZH / SWA / LSZH (2 CORES - 5 CORES)

XLPE Insulated, LSZH Bedded, Galvanised Steel Wire Armoured, LSZH Sheathed Cable, 0.6 / 1kV, BS6724

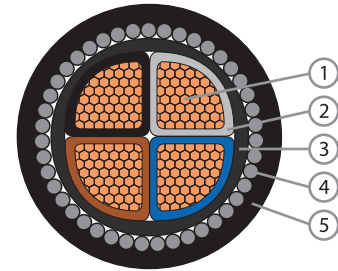
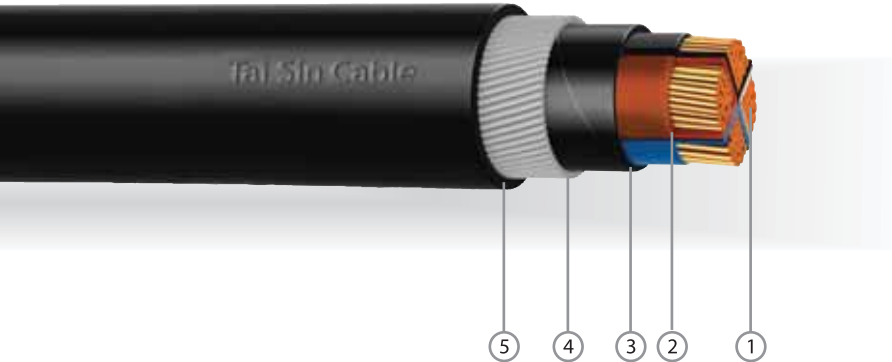

- Component**
1. Plain Annealed Copper Wire
 2. Cross-linked Polyethylene Compound
 3. Low Smoke Zero Halogen (LSZH) Compound
 4. Galvanised Steel Wire Armoured
 5. Low Smoke Zero Halogen (LSZH) Compound

CONSTRUCTION

Conductor:	Plain Annealed Copper, Class 2 Stranded Circular, Compacted or Sectored
Insulation:	Cross-linked Polyethylene (XLPE) Compound
Insulation Colour:	2 Cores: Brown, Blue or Red, Black 3 Cores: Brown, Black, Grey or Red, Yellow, Blue 4 Cores: Brown, Black, Grey, Blue or Red, Yellow, Blue, Black 5 Cores: Brown, Black, Grey, Blue, Green/Red, Yellow, Blue, Black, Green/Yellow or White with Black numbering or Others
Assembly:	Cores cabled together with filler and covered with Polyester (PET) Tape
Bedding:	Low Smoke Zero Halogen (LSZH) Compound
Bedding Colour:	Black
Armour:	Galvanized Steel Wire Armoured (SWA)
Outer Sheath:	Low Smoke Zero Halogen (LSZH) Compound
Outer Sheath Colour:	Black

ELECTRICAL CHARACTERISTICS

Operating Voltage:	0.6/1kV
Operating Temperature:	-15°C to 90°C
Final Short Circuit Temperature:	250°C
Test Voltage:	3.5kV for 5 minutes

REFERENCE STANDARDS

Design Specification:	BS6724
Conductor:	IEC60228, BS EN60228
Fire Resistance:	BS6387 (C,W,Z), SS299 (C), IEC60331
Flame Retardancy:	IEC60332-3-22, BS EN60332-3-22
Low Smoke Zero Halogen:	IEC61034-2, BS EN61034-2 IEC60754-1, IEC60754-2 BS EN50267-2-1, BS EN50267-2-2

INSTALLATION REFERENCE

Min. Bending Radius (mm):	8 x cable overall diameter
Max. Pulling Tension (N/mm ²):	70

	Nominal Conductor Area (mm ²)	No. and Diameter of Wires (no./mm)	Radial Thickness of Insulation (mm)	Diameter Under Armour (mm)	Armour Wire Diameter (mm)	Cable Overall Diameter (mm)	Approximate Weight (kg/km)
2 CORES	2 x 1.5	7 / 0.53	0.6	7.6	0.9	12.3	341
	2 x 2.5	7 / 0.67	0.7	8.8	0.9	13.7	418
	2 x 4	7 / 0.85	0.7	9.9	0.9	14.8	496
	2 x 6	7 / 1.04	0.7	11.0	0.9	15.9	585
	2 x 10	7 / 1.35	0.7	12.9	0.9	18.7	769
	2 x 16	7 / 1.70	0.7	15.0	1.25	20.8	1081
	2 x 25	7 / 2.14	0.9	18.4	1.6	25.1	1496
	2 x 35	7 / 2.52	0.9	21.1	1.6	28.0	2014
	2 x 50 (S)	19 / 1.78	1.0	20.7	1.6	27.8	2135
	2 x 70 (S)	19 / 2.14	1.1	23.7	1.6	31.0	2728
	2 x 95 (S)	19 / 2.52	1.1	26.7	2.0	35.0	3642
	2 x 120 (S)	37 / 2.03	1.2	29.5	2.0	38.0	4341
	2 x 150 (S)	37 / 2.25	1.4	32.8	2.0	41.5	5117
	2 x 185 (S)	37 / 2.52	1.6	36.8	2.5	46.9	6574
	2 x 240 (S)	61 / 2.25	1.7	40.9	2.5	51.2	8025
	2 x 300 (S)	61 / 2.52	1.8	45.3	2.5	55.8	9596

Note : (S) - Sectoral Stranded Conductors.
For current rating and voltage drop, please refer to Table B1.8 and B2.8 on Page 73.

Table 37

FRT-XSH

CU / XLPE / LSZH / SWA / LSZH (2 CORES - 5 CORES)

XLPE Insulated, LSZH Bedded, Galvanised Steel Wire Armoured, LSZH Sheathed Cable,
0.6 / 1kV, BS6724



	Nominal Conductor Area (mm ²)	No. and Diameter of Wires (no./mm)	Radial Thickness of Insulation (mm)	Diameter Under Armour (mm)	Armour Wire Diameter (mm)	Cable Overall Diameter (mm)	Approximate Weight (kg/km)
3 CORES	3 x 1.5	7 / 0.53	0.6	8.0	0.9	12.7	375
	3 x 2.5	7 / 0.67	0.7	9.4	0.9	14.3	463
	3 x 4	7 / 0.85	0.7	10.5	0.9	15.4	556
	3 x 6	7 / 1.04	0.7	11.8	0.9	16.7	669
	3 x 10	7 / 1.35	0.7	13.8	1.25	19.6	981
	3 x 16	7 / 1.70	0.7	16.1	1.25	22.1	1283
	3 x 25	7 / 2.14	0.9	20.2	1.6	27.1	1959
	3 x 35	7 / 2.52	0.9	22.6	1.6	29.7	2418
	3 x 50 (S)	19 / 1.78	1.0	23.3	1.6	30.4	2751
	3 x 70 (S)	19 / 2.14	1.1	27.0	1.6	35.1	3610
	3 x 95 (S)	19 / 2.52	1.1	30.9	1.6	39.4	4873
	3 x 120 (S)	37 / 2.03	1.2	33.9	2.0	42.6	5824
	3 x 150 (S)	37 / 2.25	1.4	38.1	2.5	48.0	7300
	3 x 185 (S)	37 / 2.52	1.6	42.9	2.5	53.0	8832
	3 x 240 (S)	61 / 2.25	1.7	48.0	2.5	58.5	10979
	3 x 300 (S)	61 / 2.52	1.8	52.3	2.5	63.0	13153
3 x 400 (S)	61 / 2.85	2.0	60.8	2.5	71.9	16378	
4 CORES	4 x 1.5	7 / 0.53	0.6	8.8	0.9	13.5	416
	4 x 2.5	7 / 0.67	0.7	10.3	0.9	15.2	526
	4 x 4	7 / 0.85	0.7	11.6	0.9	16.5	642
	4 x 6	7 / 1.04	0.7	13.0	1.25	18.8	880
	4 x 10	7 / 1.35	0.7	15.2	1.25	21.0	1156
	4 x 16	7 / 1.70	0.7	17.8	1.25	24.5	1531
	4 x 25	7 / 2.14	0.9	22.3	1.6	29.2	2335
	4 x 35	7 / 2.52	0.9	25.1	1.6	32.2	2914
	4 x 50 (S)	19 / 1.78	1.0	25.3	1.6	32.6	3351
	4 x 70 (S)	19 / 2.14	1.1	29.7	2.0	38.2	4717
	4 x 95 (S)	19 / 2.52	1.1	33.4	2.0	42.1	5988
	4 x 120 (S)	37 / 2.03	1.2	37.2	2.5	47.1	7625
	4 x 150 (S)	37 / 2.25	1.4	42.7	2.5	52.8	9164
	4 x 185 (S)	37 / 2.52	1.6	47.3	2.5	57.8	11059
	4 x 240 (S)	61 / 2.25	1.7	54.6	2.5	65.3	13939
	4 x 300 (S)	61 / 2.52	1.8	60.5	2.5	71.6	16865
4 x 400 (S)	61 / 2.85	2.0	69.7	3.15	82.7	21985	
5 CORES	5 x 1.5	7 / 0.53	0.6	9.6	0.9	14.5	478
	5 x 2.5	7 / 0.67	0.7	11.3	0.9	16.2	599
	5 x 4	7 / 0.85	0.7	12.7	0.9	18.5	752
	5 x 6	7 / 1.04	0.7	14.3	1.25	20.1	1007
	5 x 10	7 / 1.35	0.7	16.8	1.25	22.8	1352
	5 x 16	7 / 1.70	0.7	20.0	1.6	26.9	1977
	5 x 25	7 / 2.14	0.9	24.7	1.6	31.8	2764
	5 x 35	7 / 2.52	0.9	27.7	1.6	35.0	3456
	5 x 50	19 / 1.78	1.0	32.7	2.0	41.0	4553
	5 x 70	19 / 2.14	1.1	38.1	2.0	46.8	5961

Note : (S) - Sectoral Stranded Conductors.
For current rating and voltage drop, please refer to Table B1.8 and B2.8 on Page 73.

Table 38

FRT-XSH

CU / XLPE / LSZH / SWA / LSZH (MULTI-CORES)

XLPE Insulated, LSZH Bedded, Galvanised Steel Wire Armoured, LSZH Sheathed Cable, 0.6 / 1kV, BS6724

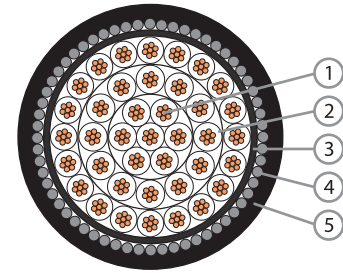
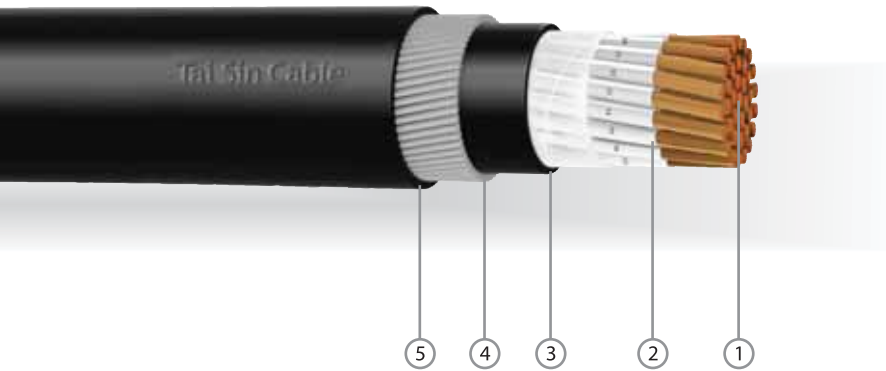

- Component**
1. Plain Annealed Copper Wire
 2. Cross-linked Polyethylene Compound
 3. Low Smoke Zero Halogen (LSZH) Compound
 4. Galvanised Steel Wire Armoured
 5. Low Smoke Zero Halogen (LSZH) Compound

CONSTRUCTION

Conductor:	Plain Annealed Copper, Class 2 Stranded Circular or Compacted
Insulation:	Cross-linked Polyethylene (XLPE) Compound
Insulation Colour:	White with Black numbering or Others
Assembly:	Cores cabled together and covered with Polyester (PET) Tape
Bedding:	Low Smoke Zero Halogen (LSZH) Compound
Bedding Colour:	Black
Armour:	Galvanized Steel Wire Armoured (SWA)
Outer Sheath:	Low Smoke Zero Halogen (LSZH) Compound
Outer Sheath Colour:	Black

ELECTRICAL CHARACTERISTICS

Operating Voltage:	0.6/1kV
Operating Temperature:	-15°C to 90°C
Final Short Circuit Temperature:	250°C
Test Voltage:	3.5kV for 5 minutes

REFERENCE STANDARDS

Design Specification:	BS6724
Conductor:	IEC60228, BS EN60228
Fire Resistance:	BS6387 (C,W,Z), SS299 (C), IEC60331
Flame Retardancy:	IEC60332-3-22, BS EN60332-3-22
Low Smoke Zero Halogen:	IEC61034-2, BS EN61034-2 IEC60754-1, IEC60754-2 BS EN50267-2-1, BS EN50267-2-2

INSTALLATION REFERENCE

Min. Bending Radius (mm):	8 x cable overall diameter
Max. Pulling Tension (N/mm ²):	70

No. of Cores	Nominal Conductor Area (mm ²)	No. and Diameter of Wires (no./mm)	Radial Thickness of Insulation (mm)	Diameter Under Armour (mm)	Armour Wire Diameter (mm)	Cable Overall Diameter (mm)	Approximate Weight (kg/km)
5	1.5	7 / 0.53	0.6	9.6	0.9	14.5	478
7		7 / 0.53	0.6	10.5	0.9	15.4	571
10		7 / 0.53	0.6	13.4	1.25	19.2	849
12		7 / 0.53	0.6	13.8	1.25	19.6	908
19		7 / 0.53	0.6	16.3	1.25	22.3	1168
20		7 / 0.53	0.6	17.6	1.6	23.8	1396
24		7 / 0.53	0.6	19.5	1.6	26.4	1594
37		7 / 0.53	0.6	22.4	1.6	29.3	2015

Note : Other conductor sizes & core configurations are available upon request.
For current rating and voltage drop, please refer to Table B1.8 and B2.8 on Page 73.

Table 39

MULTI-CORES

FRT-XSH

CU / XLPE / LSZH / SWA / LSZH (**MULTI-CORES**)

XLPE Insulated, LSZH Bedded, Galvanised Steel Wire Armoured, LSZH Sheathed Cable,
0.6 / 1kV, BS6724



No. of Cores	Nominal Conductor Area (mm ²)	No. and Diameter of Wires (no./mm)	Radial Thickness of Insulation (mm)	Diameter Under Armour (mm)	Armour Wire Diameter (mm)	Cable Overall Diameter (mm)	Approximate Weight (kg/km)
5	2.5	7 / 0.67	0.7	11.3	0.9	16.2	599
7		7 / 0.67	0.7	12.3	0.9	17.9	729
10		7 / 0.67	0.7	15.8	1.25	21.8	1079
12		7 / 0.67	0.7	16.4	1.25	22.4	1172
19		7 / 0.67	0.7	19.8	1.6	26.7	1704
20		7 / 0.67	0.7	20.9	1.6	28.0	1823
24		7 / 0.67	0.7	23.3	1.6	30.4	2066
37		7 / 0.67	0.7	26.8	1.6	33.9	2659
<hr/>							
5	4	7 / 0.85	0.7	12.7	1.25	18.5	842
7		7 / 0.85	0.7	14.0	1.25	19.8	1002
10		7 / 0.85	0.7	18.4	1.25	25.1	1504
12		7 / 0.85	0.7	19.0	1.6	25.7	1626
19		7 / 0.85	0.7	22.5	1.6	29.4	2150
20		7 / 0.85	0.7	23.8	1.6	31.1	2289
24		7 / 0.85	0.7	26.5	2.0	33.8	2633
37		7 / 0.85	0.7	31.0	2.0	39.3	3759

Note : Other conductor sizes & core configurations are available upon request.
For current rating and voltage drop, please refer to Table B1.8 and B2.8 on Page 73.

Table 40

FRT-XCH

CU / XLPE / LSZH / CT / LSZH (3 CORES + 3 EARTH)

XLPE Insulated, LSZH Bedded, Copper Tape Screened, LSZH Sheathed Cable, 0.6 / 1kV, IEC60502

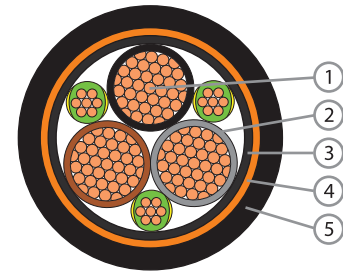
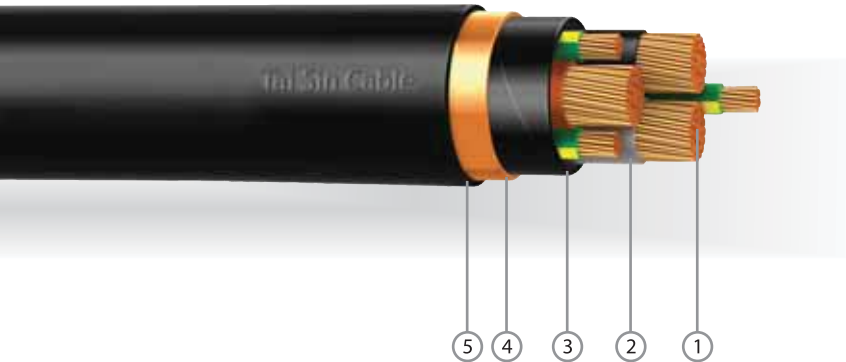

- Component**
1. Plain Annealed Copper Wire
 2. Cross-linked Polyethylene Compound
 3. Low Smoke Zero Halogen (LSZH) Compound
 4. Copper Tape
 5. Low Smoke Zero Halogen (LSZH) Compound

CONSTRUCTION

Conductor:	Plain Annealed Copper, Class 2 Stranded Circular or Compacted
Insulation:	Cross-linked Polyethylene (XLPE) Compound
Insulation Colour:	Brown, Black, Grey, Green/Yellow (x3) or Red, Yellow, Blue, Green/Yellow (x3) or Others
Assembly:	Cores cabled together with filler and covered with Polyester (PET) Tape
Bedding:	Low Smoke Zero Halogen (LSZH) Compound
Bedding Colour:	Black
Screen:	Copper Tape
Outer Sheath:	Low Smoke Zero Halogen (LSZH) Compound
Outer Sheath Colour:	Black

ELECTRICAL CHARACTERISTICS

Operating Voltage:	0.6/1kV
Operating Temperature:	-15°C to 90°C
Final Short Circuit Temperature:	250°C
Test Voltage:	3.5kV for 5 minutes

REFERENCE STANDARDS

Design Specification:	IEC60502-1
Conductor:	IEC60228, BS EN60228
Flame Retardancy:	IEC60332-3-22, BS EN60332-3-22
Low Smoke Zero Halogen:	IEC61034-2, BS EN61034-2 IEC60754-1, IEC60754-2 BS EN50267-2-1, BS EN50267-2-2

INSTALLATION REFERENCE

Min. Bending Radius (mm):	8 x cable overall diameter
Max. Pulling Tension (N/mm ²):	50

	3 CORES + 3 EARTH						
	Nominal Conductor Area (mm ²)	Combined Earth Size (mm ²)	No. and Diameter of Wires (no./mm)	Radial Thickness of Insulation (mm)	Diameter Under Screen (mm)	Cable Overall Diameter (mm)	Approximate Weight (kg/km)
	3 x 1.5	4.5 (3 x 1.5)	7 / 0.53	0.7	11.7	16.8	485
	3 x 2.5	4.5 (3 x 1.5)	7 / 0.67	0.7	12.3	17.4	532
	3 x 4	4.5 (3 x 1.5)	7 / 0.85	0.7	13.1	18.2	602
	3 x 6	7.5 (3 x 2.5)	7 / 1.04	0.7	14.6	19.7	734
	3 x 10	12 (3 x 4)	7 / 1.35	0.7	16.8	21.9	966
	3 x 16	18 (3 x 6)	7 / 1.70	0.7	19.2	24.3	1271
	3 x 25	30 (3 x 10)	7 / 2.14	0.9	23.2	28.3	1796
	3 x 35	30 (3 x 10)	7 / 2.52	0.9	24.9	30.0	2131
	3 x 50	30 (3 x 10)	19 / 1.78	1.0	27.4	32.7	2743
	3 x 70	48 (3 x 16)	19 / 2.14	1.1	32.4	37.9	3763
	3 x 95	48 (3 x 16)	19 / 2.52	1.1	35.2	40.9	4658
	3 x 120	75 (3 x 25)	37 / 2.03	1.2	40.9	46.4	5905
	3 x 150	75 (3 x 25)	37 / 2.25	1.4	43.8	49.9	6919
	3 x 185	105 (3 x 35)	37 / 2.52	1.6	49.0	55.5	8584
	3 x 240	150 (3 x 50)	61 / 2.25	1.7	56.3	63.4	11343
	3 x 300	150 (3 x 50)	61 / 2.52	1.8	60.3	67.6	13373

For current rating and voltage drop, please refer to Table B1.6 and B2.6 on Page 71.

Table 41

FRT-XCH

CU / XLPE / LSZH / CT / LSZH (4 CORES)

XLPE Insulated, LSZH Bedded, Copper Tape Screened, LSZH Sheathed Cable, 0.6 / 1kV, IEC60502

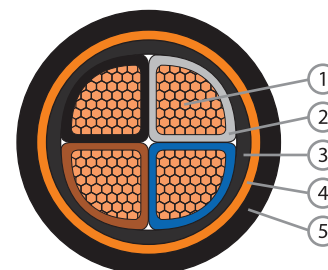

- Component**
1. Plain Annealed Copper Wire
 2. Cross-linked Polyethylene Compound
 3. Low Smoke Zero Halogen (LSZH) Compound
 4. Copper Tape
 5. Low Smoke Zero Halogen (LSZH) Compound

CONSTRUCTION

Conductor:	Plain Annealed Copper, Class 2 Stranded Circular, Compacted or Sectored
Insulation:	Cross-linked Polyethylene (XLPE) Compound
Insulation Colour:	Brown, Black, Grey, Blue or Red, Yellow, Blue, Black or Others
Assembly:	Cores cabled together with filler and covered with Polyester (PET) Tape
Bedding:	Low Smoke Zero Halogen (LSZH) Compound
Bedding Colour:	Black
Screen:	Copper Tape
Outer Sheath:	Low Smoke Zero Halogen (LSZH) Compound
Outer Sheath Colour:	Black

ELECTRICAL CHARACTERISTICS

Operating Voltage, U ₀ /U:	0.6/1kV
Operating Temperature:	-15°C to 90°C
Final Short Circuit Temperature:	250°C
Test Voltage:	3.5kV for 5 minutes

REFERENCE STANDARDS

Design Specification:	IEC60502-1
Conductor:	IEC60228, BS EN60228
Flame Retardancy:	IEC60332-1, BS EN60332-1

INSTALLATION REFERENCE

Min. Bending Radius (mm):	8 x cable overall diameter
Max. Pulling Tension (N/mm ²):	50

	Nominal Conductor Area (mm ²)	No. and Diameter of Wires (no./mm)	Radial Thickness of Insulation (mm)	Diameter Under Screen (mm)	Cable Overall Diameter (mm)	Approximate Weight (kg/km)
4 CORES	4 x 1.5	7 / 0.53	0.7	9.7	14.4	371
	4 x 2.5	7 / 0.67	0.7	10.7	15.4	441
	4 x 4	7 / 0.85	0.7	12.0	16.7	544
	4 x 6	7 / 1.04	0.7	13.4	18.1	668
	4 x 10	7 / 1.35	0.7	15.6	20.3	907
	4 x 16	7 / 1.70	0.7	18.2	22.9	1229
	4 x 25	7 / 2.14	0.9	22.3	27.0	1770
	4 x 35 (S)	7 / 2.52	0.9	25.1	29.8	2264
	4 x 50 (S)	19 / 1.78	1.0	25.4	30.3	2721
	4 x 70 (S)	19 / 2.14	1.1	29.8	34.9	3734
	4 x 95 (S)	19 / 2.52	1.1	33.5	39.0	5069
	4 x 120 (S)	37 / 2.03	1.2	37.3	43.0	6254
	4 x 150 (S)	37 / 2.25	1.4	42.8	48.9	7622
	4 x 185 (S)	37 / 2.52	1.6	47.4	53.7	9333
	4 x 240 (S)	61 / 2.25	1.7	54.7	61.8	12296
	4 x 300 (S)	61 / 2.52	1.8	60.6	67.9	15030

Note: (S) - Sectoral Stranded Conductors.
For current rating and voltage drop, please refer to Table B1.6 and B2.6 on Page 71.

Table 42

FRT-XCAH

CU / XLPE / LSZH / CT / LSZH / AWA / LSZH (SINGLE CORE)

XLPE Insulated, LSZH Bedded, Copper Tape Screened, LSZH Separation Sheath, Aluminium Wire Armoured, LSZH Sheathed Cable, 0.6 / 1kV, IEC60502

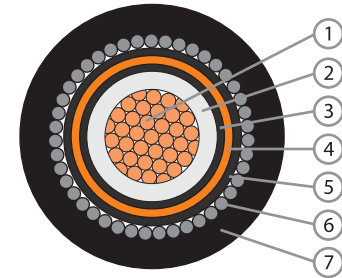

Component

1. Plain Annealed Copper Wire
2. Cross-linked Polyethylene Compound
3. Low Smoke Zero Halogen (LSZH) Compound
4. Copper Tape
5. Low Smoke Zero Halogen (LSZH) Compound
6. Aluminium Wire Armoured
7. Low Smoke Zero Halogen (LSZH) Compound

CONSTRUCTION

Conductor:	Plain Annealed Copper, Class 2 Stranded Circular or Compacted
Insulation:	Cross-linked Polyethylene (XLPE) Compound
Insulation Colour:	Natural
Bedding:	Low Smoke Zero Halogen (LSZH) Compound
Bedding Colour:	Black
Screen:	Copper Tape
Separation Sheath:	Low Smoke Zero Halogen (LSZH) Compound
Separation Sheath Colour:	Black
Armour:	Aluminium Wire Armoured (AWA)
Outer Sheath:	Low Smoke Zero Halogen (LSZH) Compound
Outer Sheath Colour:	Black

ELECTRICAL CHARACTERISTICS

Operating Voltage:	0.6/1kV
Operating Temperature:	-15°C to 90°C
Final Short Circuit Temperature:	250°C
Test Voltage:	3.5kV for 5 minutes

REFERENCE STANDARDS

Design Specification:	IEC60502-1
Conductor:	IEC60228, BS EN60228
Flame Retardancy:	IEC60332-3-22, BS EN60332-3-22
Low Smoke Zero Halogen:	IEC61034-2, BS EN61034-2 IEC60754-1, IEC60754-2 BS EN50267-2-1, BS EN50267-2-2

INSTALLATION REFERENCE

Min. Bending Radius (mm):	8 x cable overall diameter
Max. Pulling Tension (N/mm ²):	50

	Nominal Conductor Area (mm ²)	No. and Diameter of Wires (no./mm)	Radial Thickness of Insulation (mm)	Diameter Under Screen (mm)	Diameter Under Armour (mm)	Armour Wire Diameter (mm)	Cable Overall Diameter (mm)	Approximate Weight (kg/km)
SINGLE CORE	1 x 70	19 / 2.14	1.1	15.3	18.7	1.6	25.7	1677
	1 x 95	19 / 2.52	1.1	17.2	20.6	1.6	27.6	2111
	1 x 120	37 / 2.03	1.2	19.0	22.4	1.6	29.4	2463
	1 x 150	37 / 2.25	1.4	21.0	24.6	1.6	31.4	2846
	1 x 185	37 / 2.52	1.6	23.2	26.8	1.6	34.0	3533
	1 x 240	61 / 2.25	1.7	26.1	29.7	2.0	37.9	4383
	1 x 300	61 / 2.52	1.8	28.7	32.3	2.0	40.7	5181
	1 x 400	61 / 2.85	2.0	32.5	36.1	2.0	44.7	6317
	1 x 500	61 / 3.20	2.2	36.0	39.6	2.0	48.4	7578
	1 x 630	127 / 2.52	2.4	40.4	44.2	2.5	54.4	9505
	1 x 800	127 / 2.85	2.6	45.5	49.5	2.5	59.9	11694
	1 x 1000	127 / 3.20	2.8	50.4	54.6	2.5	65.4	14193

For current rating and voltage drop, please refer to Table B1.7 and B2.7 on Page72.

Table 43

FRT-XCSH

CU / XLPE / LSZH / CT / LSZH (4 CORES)

XLPE Insulated, LSZH Bedded, Copper Tape Screened, LSZH Separation Sheath, Galvanised Steel Wire Armoured, LSZH Sheathed Cable, 0.6 / 1kV, IEC60502

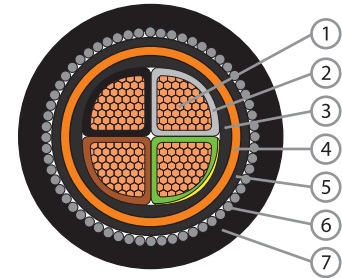

Component

1. Plain Annealed Copper Wire
2. Cross-linked Polyethylene Compound
3. Low Smoke Zero Halogen (LSZH) Compound
4. Copper Tape
5. Low Smoke Zero Halogen (LSZH) Compound
6. Galvanised Steel Wire Armoured
7. Low Smoke Zero Halogen (LSZH) Compound

CONSTRUCTION

Conductor:	Plain Annealed Copper, Class 2 Stranded Circular, Compacted or Sectored
Insulation:	Cross-linked Polyethylene (XLPE) Compound
Insulation Colour:	Brown, Black, Grey, Green/Yellow or Red, Yellow, Blue, Green/Yellow or Others
Assembly:	Cores cabled together with filler and covered with Polyester (PET) Tape
Bedding:	Low Smoke Zero Halogen (LSZH) Compound
Bedding Colour:	Black
Screen:	Copper Tape
Separation Sheath:	Low Smoke Zero Halogen (LSZH) Compound
Separation Sheath Colour:	Black
Armour:	Galvanized Steel Wire Armoured (SWA)
Outer Sheath:	Low Smoke Zero Halogen (LSZH) Compound
Outer Sheath Colour:	Black

ELECTRICAL CHARACTERISTICS

Operating Voltage:	0.6/1kV
Operating Temperature:	-15°C to 90°C
Final Short Circuit Temperature:	250°C
Test Voltage:	3.5kV for 5 minutes

REFERENCE STANDARDS

Design Specification:	IEC60502-1
Conductor:	IEC60228, BS EN60228
Flame Retardancy:	IEC60332-3-22, BS EN60332-3-22
Low Smoke Zero Halogen:	IEC61034-2, BS EN61034-2 IEC60754-1, IEC60754-2 BS EN50267-2-1, BS EN50267-2-2

INSTALLATION REFERENCE

Min. Bending Radius (mm):	8 x cable overall diameter
Max. Pulling Tension (N/mm ²):	70

	Nominal Conductor Area (mm ²)	No. and Diameter of Wires (no./mm)	Radial Thickness of Insulation (mm)	Diameter Under Screen (mm)	Diameter Under Armour (mm)	Armour Wire Diameter (mm)	Cable Overall Diameter (mm)	Approximate Weight (kg/km)
4 CORES	4 x 1.5	7 / 0.53	0.7	9.7	13.1	1.25	19.9	871
	4 x 2.5	7 / 0.67	0.7	10.7	14.1	1.25	20.9	981
	4 x 4	7 / 0.85	0.7	12.0	15.4	1.25	22.2	1127
	4 x 6	7 / 1.04	0.7	13.4	16.8	1.25	23.6	1304
	4 x 10	7 / 1.35	0.7	15.6	19.0	1.6	26.5	1758
	4 x 16	7 / 1.70	0.7	18.2	21.6	1.6	29.1	2186
	4 x 25	7 / 2.14	0.9	22.3	25.7	1.6	33.4	2915
	4 x 35	7 / 2.52	0.9	25.1	28.5	1.6	36.4	3535
	4 x 50 (S)	19 / 1.78	1.0	25.4	28.8	2.0	37.7	4370
	4 x 70 (S)	19 / 2.14	1.1	29.8	33.2	2.0	42.5	5651
	4 x 95 (S)	19 / 2.52	1.1	33.5	37.1	2.5	47.6	7413
	4 x 120 (S)	37 / 2.03	1.2	37.3	41.1	2.5	52.0	8888
	4 x 150 (S)	37 / 2.25	1.4	42.8	46.8	2.5	58.1	10632
	4 x 185 (S)	37 / 2.52	1.6	47.4	51.4	2.5	62.9	12641
	4 x 240 (S)	61 / 2.25	1.7	54.7	59.3	2.5	71.2	16133
	4 x 300 (S)	61 / 2.52	1.8	60.6	65.4	3.15	79.2	20227

Note: (S) - Sectoral Stranded Conductors.
For current rating and voltage drop, please refer to Table B1.8 and B2.8 on Page 73.

Table 44

FR-H

CU / MGT / LSZH (SINGLE CORE)

Mica Taped, Cross-linked Polyolefin LSZH Insulated, Non-Sheathed Cable, 450 / 750V (0.6 / 1kV*), BS7211

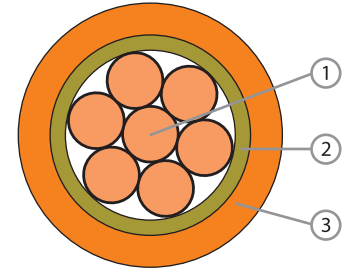
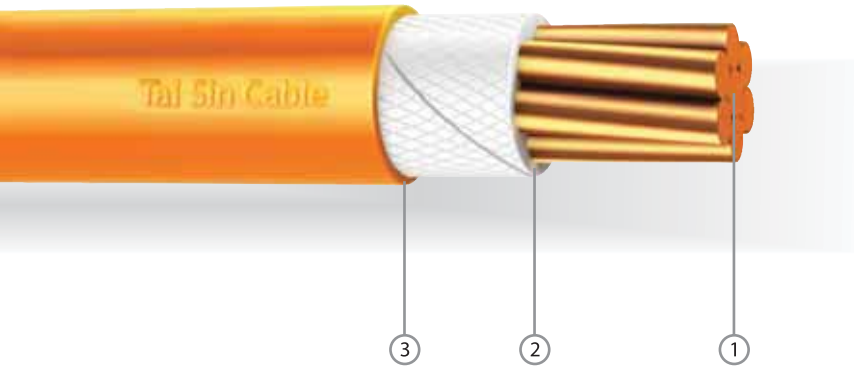

- Component**
1. Plain Annealed Copper Wire
 2. Mica Tape
 3. Cross-linked Polyolefin Low Smoke Zero Halogen Compound

CONSTRUCTION

Conductor:	Plain Annealed Copper, Class 2 Stranded Circular or Compacted
Fire Barrier:	Mica Tape (MGT)
Insulation:	Cross-linked Polyolefin (LSZH) Low Smoke Zero Halogen Compound
Insulation Colour:	Orange or Others

ELECTRICAL CHARACTERISTICS

Operating Voltage:	450 / 750V (0.6/1kV*)
Operating Temperature:	-15°C to 90°C
Final Short Circuit Temperature:	250°C
Test Voltage:	3.5kV for 5 minutes

REFERENCE STANDARDS

Design Specification:	BS7211
Conductor:	IEC60228, BS EN60228
Fire Resistance:	BS6387 (C,W,Z), SS299 (C), IEC60331
Flame Retardancy:	IEC60332-3-22, BS EN60332-3-22
Low Smoke Zero Halogen:	IEC61034-2, BS EN61034-2 IEC60754-1, IEC60754-2 BS EN50267-2-1, BS EN50267-2-2

INSTALLATION REFERENCE

Min. Bending Radius (mm):	8 x cable overall diameter
Max. Pulling Tension (N/mm ²):	50

SINGLE CORE	Nominal Conductor Area (mm ²)	No. and Diameter of Wires (no./mm)	Radial Thickness of Insulation (mm)	Cable Overall Diameter (mm)	Approximate Weight (kg/km)
	1 x 1.5	7 / 0.53	0.7	4.1	32
1 x 2.5	7 / 0.67	0.8	4.8	46	
1 x 4	7 / 0.85	0.8	5.3	62	
1 x 6	7 / 1.04	0.8	5.9	84	
1 x 10	7 / 1.35	1.0	7.3	135	
1 x 16	7 / 1.70	1.0	8.3	195	
1 x 25	7 / 2.14	1.2	10.1	299	
1 x 35	7 / 2.52	1.2	11.2	397	
1 x 50	19 / 1.78	1.4	12.9	533	
1 x 70	19 / 2.14	1.4	14.7	740	
1 x 95	19 / 2.52	1.6	17.0	1015	
1 x 120	37 / 2.03	1.6	18.7	1257	
1 x 150	37 / 2.25	1.8	20.6	1524	
1 x 185	37 / 2.52	2.0	22.9	1926	
1 x 240	61 / 2.25	2.2	25.9	2510	
1 x 300	61 / 2.52	2.4	28.7	3131	
1 x 400	61 / 2.85	2.6	32.1	3975	
1 x 500	61 / 3.20	2.8	35.6	4978	
1 x 630	127 / 2.52	2.8	39.6	6333	

Note: For FR-H cables, Cross-linked LSZH Compound will be used as the insulation material.
For current rating and voltage drop, please refer to Table B1.5 and B2.5 on Page 70.
* Condition apply.

Table 45

FR-XH

CU / MGT / XLPE / LSZH (SINGLE CORE)

Mica Taped, XLPE Insulated, LSZH Sheathed Cable, 0.6 / 1kV, IEC60502

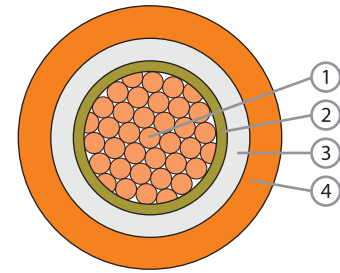
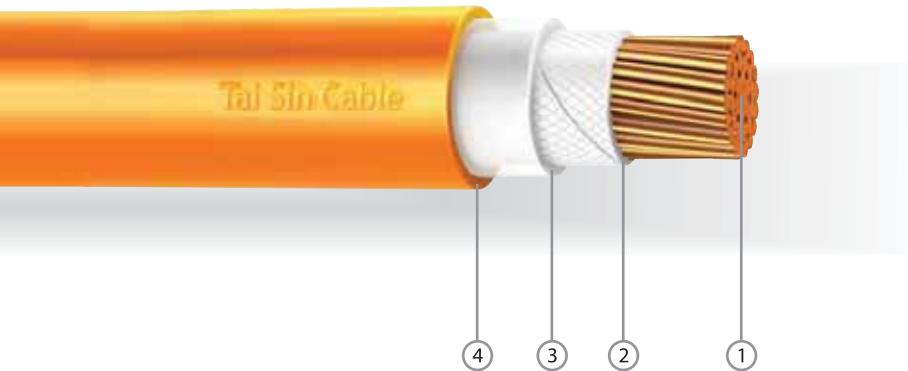

- Component**
1. Plain Annealed Copper Wire
 2. Mica Tape
 3. Cross-linked Polyethylene Compound
 4. Low Smoke Zero Halogen (LSZH) Compound

CONSTRUCTION

Conductor:	Plain Annealed Copper, Class 2 Stranded Circular or Compacted
Fire Barrier:	Mica Tape (MGT)
Insulation:	Cross-linked Polyethylene (XLPE) Compound
Insulation Colour:	Natural
Outer Sheath:	Low Smoke Zero Halogen (LSZH) Compound
Outer Sheath Colour:	Orange or Others

REFERENCE STANDARDS

Design Specification:	IEC60502-1
Conductor:	IEC60228, BS EN60228
Fire Resistance:	BS6387 (C,W,Z), SS299 (C), IEC60331
Flame Retardancy:	IEC60332-3-22, BS EN60332-3-22
Low Smoke Zero Halogen:	IEC61034-2, BS EN61034-2 IEC60754-1, IEC60754-2 BS EN50267-2-1, BS EN50267-2-2

ELECTRICAL CHARACTERISTICS

Operating Voltage:	0.6/1kV
Operating Temperature:	-15°C to 90°C
Final Short Circuit Temperature:	250°C
Test Voltage:	3.5kV for 5 minutes

INSTALLATION REFERENCE

Min. Bending Radius (mm):	8 x cable overall diameter
Max. Pulling Tension (N/mm ²):	50

	Nominal Conductor Area (mm ²)	No. and Diameter of Wires (no./mm)	Radial Thickness of Insulation (mm)	Cable Overall Diameter (mm)	Approximate Weight (kg/km)
	1 x 1.5	7 / 0.53	0.7	6.1	78
	1 x 2.5	7 / 0.67	0.7	6.5	92
	1 x 4	7 / 0.85	0.7	7.1	114
	1 x 6	7 / 1.04	0.7	7.6	141
	1 x 10	7 / 1.35	0.7	8.6	192
	1 x 16	7 / 1.70	0.7	9.6	261
	1 x 25	7 / 2.14	0.9	11.3	376
	1 x 35	7 / 2.52	0.9	12.5	482
SINGLE CORE	1 x 50	19 / 1.78	1.0	14.1	624
	1 x 70	19 / 2.14	1.1	16.1	851
	1 x 95	19 / 2.52	1.1	18.2	1131
	1 x 120	37 / 2.03	1.2	20.0	1393
	1 x 150	37 / 2.25	1.4	22.2	1695
	1 x 185	37 / 2.52	1.6	24.4	2088
	1 x 240	61 / 2.25	1.7	27.5	2687
	1 x 300	61 / 2.52	1.8	30.3	3319
	1 x 400	61 / 2.85	2.0	33.9	4190
	1 x 500	61 / 3.20	2.2	37.6	5222
	1 x 630	127 / 2.52	2.4	42.4	6675
	1 x 800	127 / 2.85	2.6	47.3	8436
	1 x 1000	127 / 3.20	2.8	52.4	10525

For current rating and voltage drop, please refer to Table B1.5 and B2.5 on Page 70.

Table 46

FR-XH

CU / MGT / XLPE / LSZH (2 CORES - 5 CORES)

Mica Taped, XLPE Insulated, LSZH Sheathed Cable, 0.6 / 1kV, IEC60502

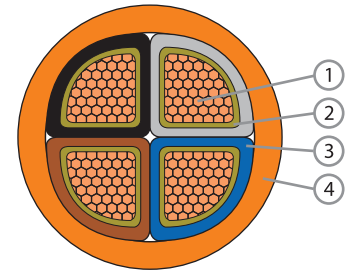

- Component**
1. Plain Annealed Copper Wire
 2. Mica Tape
 3. Cross-linked Polyethylene Compound
 4. Low Smoke Zero Halogen (LSZH) Compound

CONSTRUCTION

Conductor:	Plain Annealed Copper, Class 2 Stranded Circular, Compacted or Sectored
Fire Barrier:	Mica Tape (MGT)
Insulation:	Cross-linked Polyethylene (XLPE) Compound
Insulation Colour:	2 Cores: Brown, Blue or Red, Black 3 Cores: Brown, Black, Grey or Red, Yellow, Blue 4 Cores: Brown, Black, Grey, Blue or Red, Yellow, Blue, Black 5 Cores: Brown, Black, Grey, Blue, Green/Yellow or Red, Yellow, Blue, Black, Green/Yellow or White with Black numbering or Others
Assembly:	Cores cabled together with filler and covered with Polyester (PET) Tape
Outer Sheath:	Low Smoke Zero Halogen (LSZH) Compound
Outer Sheath Colour:	Orange or Others

ELECTRICAL CHARACTERISTICS

Operating Voltage:	0.6/1kV
Operating Temperature:	-15°C to 90°C
Final Short Circuit Temperature:	250°C
Test Voltage:	3.5kV for 5 minutes

REFERENCE STANDARDS

Design Specification:	IEC60502-1
Conductor:	IEC60228, BS EN60228
Fire Resistance:	BS6387 (C,W,Z), SS299 (C,W,Z), IEC60331
Flame Retardancy:	IEC60332-3-22, BS EN60332-3-22
Low Smoke Zero Halogen:	IEC61034-2, BS EN61034-2 IEC60754-1, IEC60754-2 BS EN50267-2-1, BS EN50267-2-2

INSTALLATION REFERENCE

Min. Bending Radius (mm):	8 x cable overall diameter
Max. Pulling Tension (N/mm ²):	50

	Nominal Conductor Area (mm ²)	No. and Diameter of Wires (no./mm)	Radial Thickness of Insulation (mm)	Cable Overall Diameter (mm)	Approximate Weight (kg/km)
	2 x 1.5	7 / 0.53	0.7	12.1	186
	2 x 2.5	7 / 0.67	0.7	12.9	223
	2 x 4	7 / 0.85	0.7	14.0	277
	2 x 6	7 / 1.04	0.7	15.1	343
	2 x 10	7 / 1.35	0.7	17.0	409
	2 x 16	7 / 1.70	0.7	19.1	639
	2 x 25	7 / 2.14	0.9	22.5	933
	2 x 35	7 / 2.52	0.9	24.8	1196
2 CORES	2 x 50 (S)	19 / 1.78	1.0	23.4	1292
	2 x 70 (S)	19 / 2.14	1.1	26.4	1750
	2 x 95 (S)	19 / 2.52	1.1	29.2	2308
	2 x 120 (S)	37 / 2.03	1.2	32.2	2852
	2 x 150 (S)	37 / 2.25	1.4	36.0	3484
	2 x 185 (S)	37 / 2.52	1.6	39.8	4302
	2 x 240 (S)	61 / 2.25	1.7	44.2	5528
	2 x 300 (S)	61 / 2.52	1.8	48.4	6806

Note: (S) - Sectoral Stranded Conductors.
For current rating and voltage drop, please refer to Table B1.6 and B2.6 on Page 71.

Table 47

FR-XH

CU / MGT / XLPE / LSZH (2 CORES - 5 CORES)

Mica Taped, XLPE Insulated, LSZH Sheathed Cable, 0.6 / 1kV, IEC60502



	Nominal Conductor Area (mm ²)	No. and Diameter of Wires (no./mm)	Radial Thickness of Insulation (mm)	Cable Overall Diameter (mm)	Approximate Weight (kg/km)
3 CORES	3 x 1.5	7 / 0.53	0.7	12.7	213
	3 x 2.5	7 / 0.67	0.7	13.6	259
	3 x 4	7 / 0.85	0.7	14.8	328
	3 x 6	7 / 1.04	0.7	16.0	413
	3 x 10	7 / 1.35	0.7	18.0	577
	3 x 16	7 / 1.70	0.7	20.3	801
	3 x 25	7 / 2.14	0.9	24.0	1183
	3 x 35	7 / 2.52	0.9	26.5	1534
	3 x 50 (S)	19 / 1.78	1.0	26.3	1826
	3 x 70 (S)	19 / 2.14	1.1	29.9	2511
	3 x 95 (S)	19 / 2.52	1.1	33.2	3331
	3 x 120 (S)	37 / 2.03	1.2	36.4	4127
	3 x 150 (S)	37 / 2.25	1.4	41.3	5056
	3 x 185 (S)	37 / 2.52	1.6	45.6	6256
	3 x 240 (S)	61 / 2.25	1.7	51.9	8082
	3 x 300 (S)	61 / 2.52	1.8	55.8	9952
3 x 400 (S)	61 / 2.85	2.0	65.2	12671	
3 x 500 (S)	61 / 3.20	2.2	71.4	15789	
4 CORES	4 x 1.5	7 / 0.53	0.7	13.8	254
	4 x 2.5	7 / 0.67	0.7	14.8	312
	4 x 4	7 / 0.85	0.7	16.1	400
	4 x 6	7 / 1.04	0.7	17.5	508
	4 x 10	7 / 1.35	0.7	19.7	718
	4 x 16	7 / 1.70	0.7	22.3	1006
	4 x 25	7 / 2.14	0.9	26.5	1496
	4 x 35	7 / 2.52	0.9	29.2	1949
	4 x 50 (S)	19 / 1.78	1.0	29.7	2367
	4 x 70 (S)	19 / 2.14	1.1	33.7	3280
	4 x 95 (S)	19 / 2.52	1.1	37.5	4364
	4 x 120 (S)	37 / 2.03	1.2	41.7	5430
	4 x 150 (S)	37 / 2.25	1.4	46.7	6634
	4 x 185 (S)	37 / 2.52	1.6	51.5	8239
	4 x 240 (S)	61 / 2.25	1.7	58.6	10648
	4 x 300 (S)	61 / 2.52	1.8	64.2	13177
4 x 400 (S)	61 / 2.85	2.0	74.1	16752	
4 x 500 (S)	61 / 3.20	2.2	84.9	20967	
5 CORES	5 x 1.5	7 / 0.53	0.7	15.0	301
	5 x 2.5	7 / 0.67	0.7	16.1	372
	5 x 4	7 / 0.85	0.7	17.5	480
	5 x 6	7 / 1.04	0.7	19.1	613
	5 x 10	7 / 1.35	0.7	21.6	872
	5 x 16	7 / 1.70	0.7	24.4	1229
	5 x 25	7 / 2.14	0.9	29.1	1835
	5 x 35	7 / 2.52	0.9	32.2	2397
	5 x 50	19 / 1.78	1.0	37.0	2979
	5 x 70	19 / 2.14	1.1	42.8	4137
	5 x 95	19 / 2.52	1.1	48.1	5505
	5 x 120	37 / 2.03	1.2	53.4	6855

Note: (S) - Sectoral Stranded Conductors.
For current rating and voltage drop, please refer to Table B1.6 and B2.6 on Page 71.

Table 48

FR-XH

CU / MGT / XLPE / LSZH (MULTI-CORES)

Mica Taped, XLPE Insulated, LSZH Sheathed Cable, 0.6 / 1kV, IEC60502

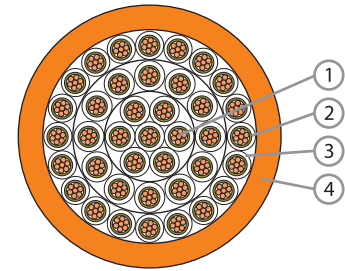
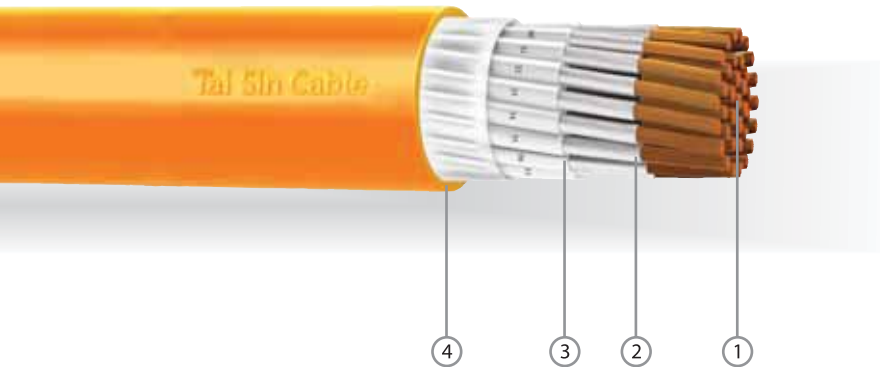

- Component**
1. Plain Annealed Copper Wire
 2. Mica Tape
 3. Cross-linked Polyethylene Compound
 4. Low Smoke Zero Halogen (LSZH) Compound

CONSTRUCTION

Conductor:	Plain Annealed Copper, Class 2 Stranded Circular or Compacted
Fire Barrier:	Mica Tape (MGT)
Insulation:	Cross-linked Polyethylene (XLPE) Compound
Insulation Colour:	White with Black numbering or Others
Assembly:	Cores cabled together and covered with Polyester (PET)Tape
Outer Sheath:	Low Smoke Zero Halogen (LSZH) Compound
Outer Sheath Colour:	Orange or Others

ELECTRICAL CHARACTERISTICS

Operating Voltage:	0.6/1kV
Operating Temperature:	-15°C to 90°C
Final Short Circuit Temperature:	250°C
Test Voltage:	3.5kV for 5 minutes

REFERENCE STANDARDS

Design Specification:	IEC60502-1
Conductor:	IEC60228, BS EN60228
Fire Resistance:	BS6387 (C,W,Z), SS299 (C,W,Z), IEC60331
Flame Retardancy:	IEC60332-3-22, BS EN60332-3-22
Low Smoke Zero Halogen:	IEC61034-2, BS EN61034-2 IEC60754-1, IEC60754-2 BS EN50267-2-1, BS EN50267-2-2

INSTALLATION REFERENCE

Min. Bending Radius (mm):	8 x cable overall diameter
Max. Pulling Tension (N/mm ²):	50

MULTI-CORES	No. of Cores	Nominal Conductor Area (mm ²)	No. and Diameter of Wires (no./mm)	Radial Thickness of Insulation (mm)	Cable Overall Diameter (mm)	Approximate Weight (kg/km)
	5	1.5	7 / 0.53	0.7	15.0	301
	7		7 / 0.53	0.7	16.4	400
	10		7 / 0.53	0.7	20.5	543
	12		7 / 0.53	0.7	21.2	608
	19		7 / 0.53	0.7	24.7	852
	20		7 / 0.53	0.7	26.0	899
	24		7 / 0.53	0.7	28.8	1050
	37		7 / 0.53	0.7	32.9	1470

Note: Other conductor sizes & core configurations are available upon request.
For current rating and voltage drop, please refer to Table B1.6 and B2.6 on Page 71.

Table 49

FR-XH

CU / MGT / XLPE / LSZH (MULTI-CORES)

Mica Taped, XLPE Insulated, LSZH Sheathed Cable, 0.6 / 1kV, IEC60502



No. of Cores	Nominal Conductor Area (mm ²)	No. and Diameter of Wires (no./mm)	Radial Thickness of Insulation (mm)	Cable Overall Diameter (mm)	Approximate Weight (kg/km)
5	2.5	7 / 0.67	0.7	16.1	372
7		7 / 0.67	0.7	17.7	490
10		7 / 0.67	0.7	22.2	670
12		7 / 0.67	0.7	22.9	756
19		7 / 0.67	0.7	26.8	1077
20		7 / 0.67	0.7	28.3	1137
24		7 / 0.67	0.7	31.3	1333
37		7 / 0.67	0.7	35.9	1892
<hr/>					
5	4	7 / 0.85	0.7	17.5	480
7		7 / 0.85	0.7	19.3	626
10		7 / 0.85	0.7	24.4	862
12		7 / 0.85	0.7	25.2	982
19		7 / 0.85	0.7	29.5	1422
20		7 / 0.85	0.7	31.1	1501
24		7 / 0.85	0.7	34.5	1766
37		7 / 0.85	0.7	39.8	2561

Note: Other conductor sizes & core configurations are available upon request.
 # For current rating and voltage drop, please refer to Table B1.6 and B2.6 on Page 71.

Table 50

FR-XAH

CU / MGT / XLPE / LSZH / AWA / LSZH (SINGLE CORE)

Mica Taped, XLPE Insulated, LSZH Bedded, Aluminium Wire Armoured, LSZH Sheathed Cable, 0.6 / 1kV, IEC60502

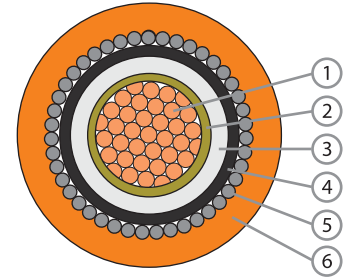
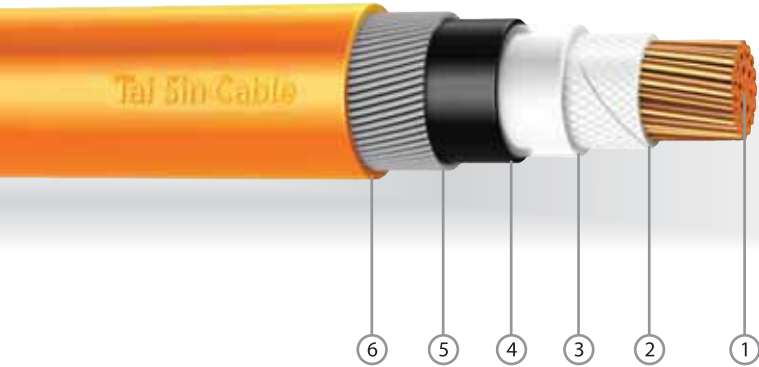

- Component**
1. Plain Annealed Copper Wire
 2. Mica Tape
 3. Cross-linked Polyethylene Compound
 4. Low Smoke Zero Halogen (LSZH) Compound
 5. Aluminium Wire Armoured
 6. Low Smoke Zero Halogen (LSZH) Compound

CONSTRUCTION

Conductor:	Plain Annealed Copper, Class 2 Stranded Circular or Compacted
Fire Barrier:	Mica Tape (MGT)
Insulation:	Cross-linked Polyethylene (XLPE) Compound
Insulation Colour:	Natural
Bedding:	Low Smoke Zero Halogen (LSZH) Compound
Bedding Colour:	Black
Armour:	Aluminium Wire Armoured (AWA)
Outer Sheath:	Low Smoke Zero Halogen (LSZH) Compound
Outer Sheath Colour:	Orange or Others

ELECTRICAL CHARACTERISTICS

Operating Voltage:	0.6/1kV
Operating Temperature:	-15°C to 90°C
Final Short Circuit Temperature:	250°C
Test Voltage:	3.5kV for 5 minutes

REFERENCE STANDARDS

Design Specification:	IEC60502-1
Conductor:	IEC60228, BS EN60228
Fire Resistance:	BS6387 (C,W,Z), SS299 (C,W,Z), IEC60331
Flame Retardancy:	IEC60332-3-22, BS EN60332-3-22
Low Smoke Zero Halogen:	IEC61034-2, BS EN61034-2 IEC60754-1, IEC60754-2 BS EN50267-2-1, BS EN50267-2-2

INSTALLATION REFERENCE

Min. Bending Radius (mm):	10 x cable overall diameter
Max. Pulling Tension (N/mm ²):	50

SINGLE CORE	Nominal Conductor Area (mm ²)	No. and Diameter of Wires (no./mm)	Radial Thickness of Insulation (mm)	Diameter Under Armour (mm)	Armour Wire Diameter (mm)	Cable Overall Diameter (mm)	Approximate Weight (kg/km)
	1 x 50	19 / 1.78	1.0	14.3	1.25	20.5	996
1 x 70	19 / 2.14	1.1	16.3	1.25	22.5	1265	
1 x 95	19 / 2.52	1.1	18.2	1.25	24.4	1573	
1 x 120	37 / 2.03	1.2	20.1	1.6	27.0	1931	
1 x 150	37 / 2.25	1.4	22.0	1.6	28.9	2269	
1 x 185	37 / 2.52	1.6	24.3	1.6	31.2	2711	
1 x 240	61 / 2.25	1.7	27.1	1.6	34.2	3379	
1 x 300	61 / 2.52	1.8	29.7	1.6	36.8	4056	
1 x 400	61 / 2.85	2.0	33.5	2.0	41.8	5168	
1 x 500	61 / 3.20	2.2	37.0	2.0	45.5	6302	
1 x 630	127 / 2.52	2.4	41.4	2.0	50.1	7856	
1 x 800	127 / 2.85	2.6	46.5	2.5	56.6	9996	
1 x 1000	127 / 3.20	2.8	51.4	2.5	61.9	12269	

For current rating and voltage drop, please refer to Table B1.7 and B2.7 on Page 72.

Table 51

FR-XSH

CU / MGT / XLPE / LSZH / SWA / LSZH (2 CORES - 5 CORES)

Mica Taped, XLPE Insulated, LSZH Bedded, Galvanised Steel Wire Armoured, LSZH Sheathed Cable, 0.6 / 1kV, BS7846

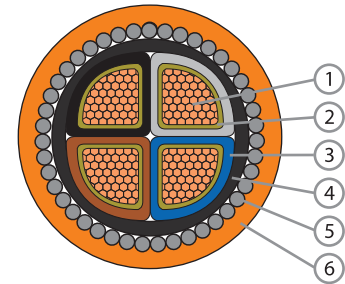
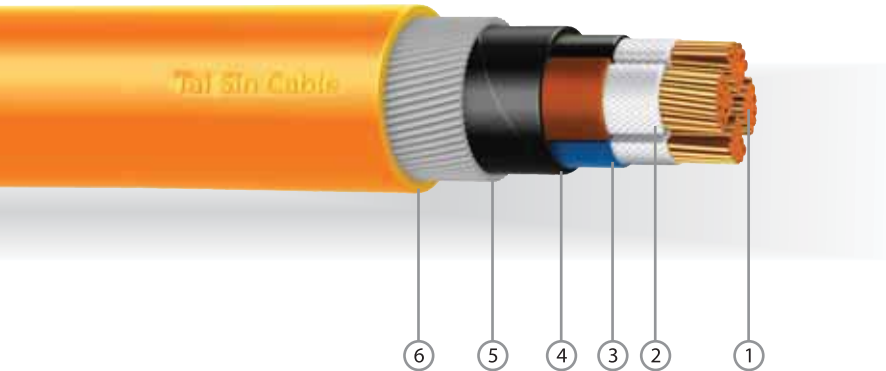

- Component**
1. Plain Annealed Copper Wire
 2. Mica Tape
 3. Cross-linked Polyethylene Compound
 4. Low Smoke Zero Halogen (LSZH) Compound
 5. Galvanised Steel Wire Armoured
 6. Low Smoke Zero Halogen (LSZH) Compound

CONSTRUCTION

Conductor:	Plain Annealed Copper, Class 2 Stranded Circular, Compacted or Sectored
Fire Barrier:	Mica Tape (MGT)
Insulation:	Cross-linked Polyethylene (XLPE) Compound
Insulation Colour:	2 Cores: Brown, Blue or Red, Black 3 Cores: Brown, Black, Grey or Red, Yellow, Blue 4 Cores: Brown, Black, Grey, Blue or Red, Yellow, Blue, Black 5 Cores: Brown, Black, Grey, Blue, Green/ Yellow or Red, Yellow, Blue, Black, Green/Yellow or White with Black numbering or Others
Assembly:	Cores cabled together with filler and covered with Polyester (PET) Tape
Bedding:	Low Smoke Zero Halogen (LSZH) Compound
Bedding Colour:	Black
Armour:	Galvanized Steel Wire Armoured (SWA)
Outer Sheath:	Low Smoke Zero Halogen (LSZH) Compound
Outer Sheath Colour:	Orange or Others

ELECTRICAL CHARACTERISTICS

Operating Voltage:	0.6/1kV
Operating Temperature:	-15°C to 90°C
Final Short Circuit Temperature:	250°C
Test Voltage:	3.5kV for 5 minutes

REFERENCE STANDARDS

Design Specification:	BS7846
Conductor:	IEC60228, BS EN60228
Fire Resistance:	BS6387 (C,W,Z), SS299 (C,W,Z), IEC60331
Flame Retardancy:	IEC60332-3-22, BS EN60332-3-22
Low Smoke Zero Halogen:	IEC61034-2, BS EN61034-2 IEC60754-1, IEC60754-2 BS EN50267-2-1, BS EN50267-2-2

INSTALLATION REFERENCE

Min. Bending Radius (mm):	10 x cable overall diameter
Max. Pulling Tension (N/mm ²):	70

	Nominal Conductor Area (mm ²)	No. and Diameter of Wires (no./mm)	Radial Thickness of Insulation (mm)	Diameter Under Armour (mm)	Armour Wire Diameter (mm)	Cable Overall Diameter (mm)	Approximate Weight (kg/km)
2 CORES	2 x 1.5	7 / 0.53	0.6	9.6	0.9	11.4	438
	2 x 2.5	7 / 0.67	0.7	11.0	0.9	16.0	531
	2 x 4	7 / 0.85	0.7	12.6	0.9	17.0	607
	2 x 6	7 / 1.04	0.7	13.2	0.9	18.2	709
	2 x 10	7 / 1.35	0.7	15.0	1.25	20.2	888
	2 x 16	7 / 1.70	0.7	17.0	1.25	22.9	1228
	2 x 25	7 / 2.14	0.9	20.6	1.6	26.7	1657
	2 x 35	7 / 2.52	0.9	23.2	1.6	30.2	2210
	2 x 50 (S)	19 / 1.78	1.0	21.8	1.6	29.0	2256
	2 x 70 (S)	19 / 2.14	1.1	24.8	1.6	32.2	2859
	2 x 95 (S)	19 / 2.52	1.1	27.8	2.0	36.2	3804
	2 x 120 (S)	37 / 2.03	1.2	30.6	2.0	39.2	4512
	2 x 150 (S)	37 / 2.25	1.4	34.0	2.0	42.8	5298
	2 x 185 (S)	37 / 2.52	1.6	38.0	2.5	48.2	6756
	2 x 240 (S)	61 / 2.25	1.7	42.0	2.5	52.4	8222
	2 x 300 (S)	61 / 2.52	1.8	46.4	2.5	57.0	9847

Note: (S) - Sectoral Stranded Conductors.
For current rating and voltage drop, please refer to Table B1.8 and B2.8 on Page 73.

FR-XSH

CU / MGT / XLPE / LSZH / SWA / LSZH (2 CORES - 5 CORES)

Mica Taped, XLPE Insulated, LSZH Bedded, Galvanised Steel Wire Armoured, LSZH Sheathed Cable, 0.6 / 1kV, BS7846



	Nominal Conductor Area (mm ²)	No. and Diameter of Wires (no./mm)	Radial Thickness of Insulation (mm)	Diameter Under Armour (mm)	Armour Wire Diameter (mm)	Cable Overall Diameter (mm)	Approximate Weight (kg/km)
3 CORES	3 x 1.5	7 / 0.53	0.6	10.2	0.9	15.0	477
	3 x 2.5	7 / 0.67	0.7	11.7	0.9	16.7	581
	3 x 4	7 / 0.85	0.7	12.8	0.9	17.8	677
	3 x 6	7 / 1.04	0.7	14.1	0.9	19.1	799
	3 x 10	7 / 1.35	0.7	16.1	1.25	22.0	1139
	3 x 16	7 / 1.70	0.7	18.2	1.25	24.3	1440
	3 x 25	7 / 2.14	0.9	22.5	1.6	29.5	2174
	3 x 35	7 / 2.52	0.9	24.9	1.6	32.1	2627
	3 x 50 (S)	19 / 1.78	1.0	24.7	1.6	31.9	2916
	3 x 70 (S)	19 / 2.14	1.1	28.1	1.6	35.5	3756
	3 x 95 (S)	19 / 2.52	1.1	31.6	2.0	40.2	5029
	3 x 120 (S)	37 / 2.03	1.2	34.6	2.0	43.4	5993
	3 x 150 (S)	37 / 2.25	1.4	39.1	2.5	49.1	7514
	3 x 185 (S)	37 / 2.52	1.6	43.6	2.5	53.8	9046
	3 x 240 (S)	61 / 2.25	1.7	49.5	2.5	60.1	11276
	3 x 300 (S)	61 / 2.52	1.8	53.6	2.5	64.4	13464
3 x 400 (S)	61 / 2.85	2.0	62.4	2.5	73.6	16724	
4 CORES	4 x 1.5	7 / 0.53	0.6	11.2	0.9	16.0	541
	4 x 2.5	7 / 0.67	0.7	12.9	0.9	17.9	667
	4 x 4	7 / 0.85	0.7	14.1	0.9	19.1	782
	4 x 6	7 / 1.04	0.7	15.6	1.25	21.5	1055
	4 x 10	7 / 1.35	0.7	17.8	1.25	23.7	1331
	4 x 16	7 / 1.70	0.7	20.2	1.25	26.3	1709
	4 x 25	7 / 2.14	0.9	24.9	1.6	31.9	2574
	4 x 35	7 / 2.52	0.9	27.6	1.6	34.8	3167
	4 x 50 (S)	19 / 1.78	1.0	28.1	1.6	35.5	3622
	4 x 70 (S)	19 / 2.14	1.1	32.1	2.0	40.7	5005
	4 x 95 (S)	19 / 2.52	1.1	35.7	2.0	44.5	6293
	4 x 120 (S)	37 / 2.03	1.2	39.3	2.5	49.3	7961
	4 x 150 (S)	37 / 2.25	1.4	44.7	2.5	54.9	9516
	4 x 185 (S)	37 / 2.52	1.6	49.1	2.5	59.7	11386
	4 x 240 (S)	61 / 2.25	1.7	56.2	2.5	67.0	14284
	4 x 300 (S)	61 / 2.52	1.8	61.4	2.5	72.6	17179
4 x 400 (S)	61 / 2.85	2.0	71.1	3.15	84.2	22343	
5 CORES	5 x 1.5	7 / 0.53	0.6	12.3	0.9	17.3	619
	5 x 2.5	7 / 0.67	0.7	14.2	0.9	19.2	755
	5 x 4	7 / 0.85	0.7	15.6	0.9	20.8	906
	5 x 6	7 / 1.04	0.7	17.2	1.25	23.1	1210
	5 x 10	7 / 1.35	0.7	19.6	1.25	25.7	1560
	5 x 16	7 / 1.70	0.7	22.7	1.6	29.7	2215
	5 x 25	7 / 2.14	0.9	27.6	1.6	34.8	3051
	5 x 35	7 / 2.52	0.9	30.6	1.6	38.0	3743
	5 x 50	19 / 1.78	1.0	35.5	2.0	43.9	4858
	5 x 70	19 / 2.14	1.1	40.9	2.0	49.7	6317
	5 x 95	19 / 2.52	1.1	46.4	2.5	56.4	8521
	5 x 120	37 / 2.03	1.2	51.5	2.5	61.9	10194

Note: (S) - Sectoral Stranded Conductors.
For current rating and voltage drop, please refer to Table B1.8 and B2.8 on Page 73.

Table 53

FR-XSH

CU / MGT / XLPE / LSZH / SWA / LSZH (MULTI-CORES)

Mica Taped, XLPE Insulated, LSZH Bedded, Galvanised Steel Wire Armoured, LSZH Sheathed Cable, 0.6 / 1kV, BS7846

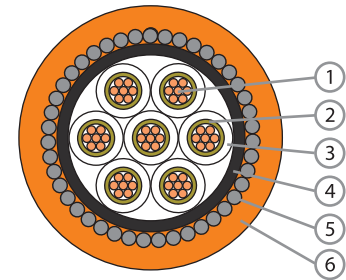
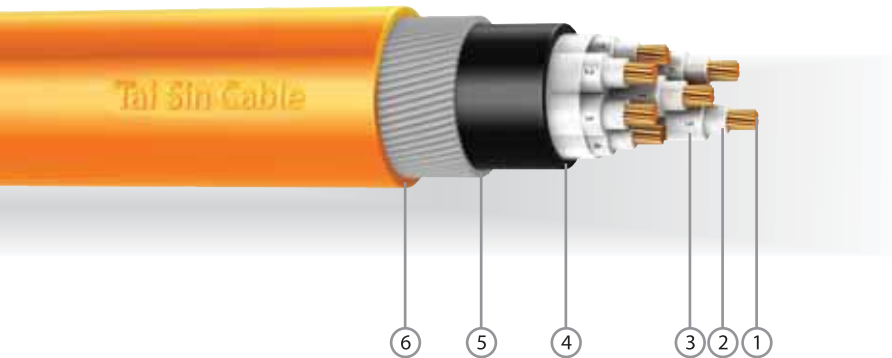

- Component**
1. Plain Annealed Copper Wire
 2. Mica Tape
 3. Cross-linked Polyethylene Compound
 4. Low Smoke Zero Halogen (LSZH) Compound
 5. Galvanised Steel Wire Armoured
 6. Low Smoke Zero Halogen (LSZH) Compound

CONSTRUCTION

Conductor:	Plain Annealed Copper, Class 2 Stranded Circular or Compacted
Fire Barrier:	Mica Tape (MGT)
Insulation:	Cross-linked Polyethylene (XLPE) Compound
Insulation Colour:	White with Black numbering or Others
Assembly:	Cores cabled together and covered with Polyester (PET) Tape
Bedding:	Low Smoke Zero Halogen (LSZH) Compound
Bedding Colour:	Black
Armour:	Galvanized Steel Wire Armoured (SWA)
Outer Sheath:	Low Smoke Zero Halogen (LSZH) Compound
Outer Sheath Colour:	Orange or Others

ELECTRICAL CHARACTERISTICS

Operating Voltage:	0.6/1kV
Operating Temperature:	-15°C to 90°C
Final Short Circuit Temperature:	250°C
Test Voltage:	3.5kV for 5 minutes

REFERENCE STANDARDS

Design Specification:	BS7846
Conductor:	IEC60228, BS EN60228
Fire Resistance:	BS6387 (C,W,Z), SS299 (C,W,Z), IEC60331
Flame Retardancy:	IEC60332-3-22, BS EN60332-3-22
Low Smoke Zero Halogen:	IEC61034-2, BS EN61034-2 IEC60754-1, IEC60754-2 BS EN50267-2-1, BS EN50267-2-2

INSTALLATION REFERENCE

Min. Bending Radius (mm):	10 x cable overall diameter
Max. Pulling Tension (N/mm ²):	70

MULTI-CORES	No. of Cores	Nominal Conductor Area (mm ²)	No. and Diameter of Wires (no./mm)	Radial Thickness of Insulation (mm)	Diameter Under Armour (mm)	Armour Wire Diameter (mm)	Cable Overall Diameter (mm)	Approximate Weight (kg/km)
		5		7 / 0.53	0.6	12.2	0.9	17.1
	7		7 / 0.53	0.6	13.4	0.9	18.3	737
	10		7 / 0.53	0.6	17.3	1.25	23.1	1102
	12		7 / 0.53	0.6	17.9	1.25	23.7	1186
	19	1.5	7 / 0.53	0.6	21.2	1.25	27.2	1526
	20		7 / 0.53	0.6	23.0	1.6	29.9	1842
	24		7 / 0.53	0.6	25.6	1.6	32.5	2084
	37		7 / 0.53	0.6	29.5	1.6	36.4	2617

Note: Other conductor sizes & core configurations are available upon request.
For current rating and voltage drop, please refer to Table B1.8 and B2.8 on Page 73.

Table 54

FR-XSH

CU / MGT / XLPE / LSZH / SWA / LSZH (MULTI-CORES)

Mica Taped, XLPE Insulated, LSZH Bedded, Galvanised Steel Wire Armoured, LSZH Sheathed Cable, 0.6 / 1kV, BS7846



No. of Cores	Nominal Conductor Area (mm ²)	No. and Diameter of Wires (no./mm)	Radial Thickness of Insulation (mm)	Diameter Under Armour (mm)	Armour Wire Diameter (mm)	Cable Overall Diameter (mm)	Approximate Weight (kg/km)
5	2.5	7 / 0.67	0.7	14.1	1.25	19.7	1007
7		7 / 0.67	0.7	15.5	1.25	21.1	1167
10		7 / 0.67	0.7	20.1	1.25	26.1	1364
12		7 / 0.67	0.7	20.8	1.25	26.8	1475
19		7 / 0.67	0.7	25.2	1.6	32.1	2159
20		7 / 0.67	0.7	26.7	1.6	33.8	2299
24		7 / 0.67	0.7	29.8	1.6	36.9	2617
37		7 / 0.67	0.7	34.4	1.6	41.5	3356
5	4	7 / 0.85	0.7	15.5	1.25	21.3	1026
7		7 / 0.85	0.7	17.0	1.25	22.8	1206
10		7 / 0.85	0.7	22.6	1.6	29.3	1827
12		7 / 0.85	0.7	23.4	1.6	30.1	1968
19		7 / 0.85	0.7	27.7	1.6	34.6	2603
20		7 / 0.85	0.7	29.4	1.6	36.7	2783
24		7 / 0.85	0.7	32.8	1.6	40.1	3192
37		7 / 0.85	0.7	38.3	2.0	46.6	4564

Note: Other conductor sizes & core configurations are available upon request.
 # For current rating and voltage drop, please refer to Table B1.8 and B2.8 on Page 73.

Table 55

FR-XL

CU / MGT / XLPE / LSZH (MULTI-CORES)

Mica Taped, XLPE Insulated, LSZH Sheathed Cable, 300 / 500V, BS EN50288-7

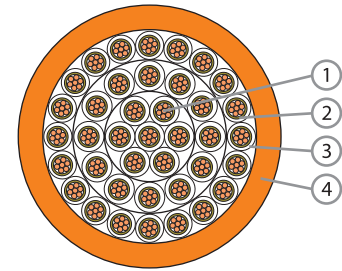
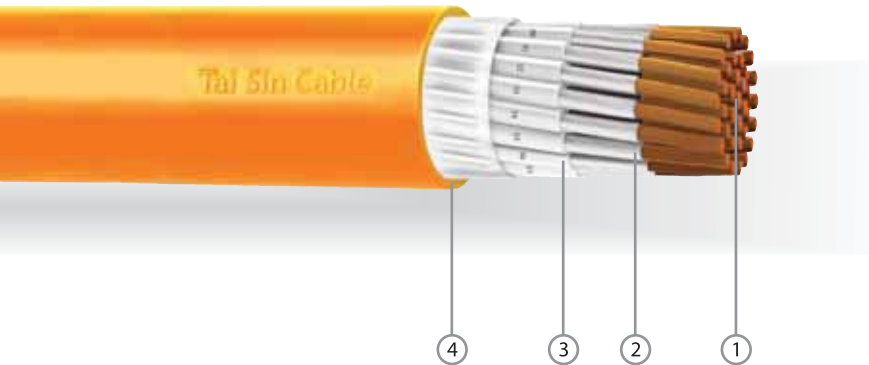

- Component**
1. Plain Annealed Copper Wire
 2. Mica Tape
 3. Cross-linked Polyethylene Compound
 4. Low Smoke Zero Halogen (LSZH) Compound

CONSTRUCTION

Conductor:	Plain Annealed Copper, Class 2 Stranded Circular or Compacted
Fire Barrier:	Mica Tape (MGT)
Insulation:	Cross-linked Polyethylene (XLPE) Compound
Insulation Colour:	2 Cores: Brown, Blue or Red, Black 3 Cores: Brown, Black, Grey or Red, Yellow, Blue 4 Cores: Brown, Black, Grey, Blue or Red, Yellow, Blue, Black 5 Cores: Brown, Black, Grey, Blue, Green/Yellow or Red, Yellow, Blue Black Green/Yellow 6 Cores and above: White with Black numberings or Others
Assembly:	Cores cabled together and covered with Polyester (PET) Tape
Outer Sheath:	Low Smoke Zero Halogen (LSZH) Compound
Outer Sheath Colour:	Orange or Others

ELECTRICAL CHARACTERISTICS

Operating Voltage:	300/500kV
Operating Temperature:	-15°C to 90°C
Final Short Circuit Temperature:	250°C
Test Voltage:	2kV for 1 minute

REFERENCE STANDARDS

Design Specification:	BS EN50288-7
Conductor:	IEC60228, BS EN60228
Fire Resistance:	BS6387 (C,W,Z), SS299 (C,W,Z), IEC60331
Flame Retardancy:	IEC60332-3-22, BS EN60332-3-22
Low Smoke Zero Halogen:	IEC61034-2, BS EN61034-2 IEC60754-1, IEC60754-2 BS EN50267-2-1, BS EN50267-2-2

INSTALLATION REFERENCE

Min. Bending Radius (mm):	8 x cable overall diameter
Max. Pulling Tension (N/mm ²):	50

MULTI-CORES	No. of Cores	Nominal Conductor Area (mm ²)	No. and Diameter of Wires (no./mm)	Radial Thickness of Insulation (mm)	Cable Overall Diameter (mm)	Approximate Weight (kg/km)
	2	1.0	7 / 0.43	0.6	9.3	90
	3		7 / 0.43	0.6	9.8	116
	4		7 / 0.43	0.6	10.8	143
	5		7 / 0.43	0.6	12.0	177
	7		7 / 0.43	0.6	13.2	232
	10		7 / 0.43	0.6	17.0	330
	12		7 / 0.43	0.6	17.6	380

Table 56

FR-XL

CU / MGT / XLPE / LSZH (MULTI-CORES)

Mica Taped, XLPE Insulated, LSZH Sheathed Cable, 300 / 500V, BS EN50288-7



No. of Cores	Nominal Conductor Area (mm ²)	No. and Diameter of Wires (no./mm)	Radial Thickness of Insulation (mm)	Cable Overall Diameter (mm)	Approximate Weight (kg/km)
2	1.5	7 / 0.53	0.6	9.9	105
3		7 / 0.53	0.6	10.5	138
4		7 / 0.53	0.6	11.7	179
5		7 / 0.53	0.6	12.8	214
7		7 / 0.53	0.6	14.1	282
10		7 / 0.53	0.6	18.2	402
12		7 / 0.53	0.6	18.8	464
MULTI-CORES	2.5	7 / 0.67	0.7	11.3	142
		7 / 0.67	0.7	12.0	188
		7 / 0.67	0.7	13.2	236
		7 / 0.67	0.7	14.5	285
		7 / 0.67	0.7	16.2	388
		7 / 0.67	0.7	20.9	551
		7 / 0.67	0.7	21.6	640
	4.0	7 / 0.85	0.7	12.4	182
		7 / 0.85	0.7	13.2	245
		7 / 0.85	0.7	14.5	310
		7 / 0.85	0.7	15.9	376

Table 57

FR-XOL

CU / MGT / XLPE / OS / LSZH (SINGLE PAIR)

Mica Taped, XLPE Insulated, Overall Aluminium Foil Screened, LSZH Sheathed Cable, 300 / 500V, BS EN50288-7

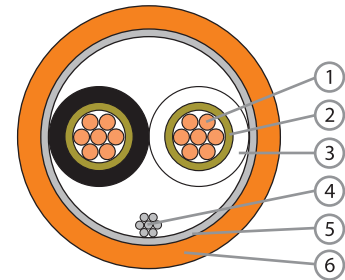
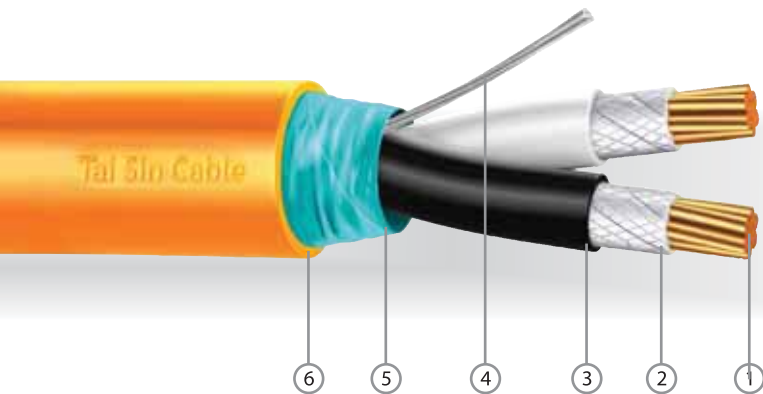

- Component**
1. Plain Annealed Copper Wire
 2. Mica Tape
 3. Cross-linked Polyethylene Compound
 4. Tinned Copper Drain Wire
 5. Aluminium / Polyester Tape
 6. Low Smoke Zero Halogen (LSZH) Compound

CONSTRUCTION

Conductor:	Plain Annealed Copper, Class 2 Stranded Circular
Fire Barrier:	Mica Tape (MGT)
Insulation:	Cross-linked Polyethylene (XLPE) Compound
Insulation Colour:	Black, White or Others
Lay Up:	Pair - Cores twisted to pair
Overall Screen:	Aluminium/Polyester Tape, with a Tinned Copper Drain Wire 0.5mm ² (7/0.3mm) (OS)
Wrap Film:	Polyester Binder Tape
Outer Sheath:	Low Smoke Zero Halogen (LSZH) Compound
Outer Sheath Colour:	Orange or Others

ELECTRICAL CHARACTERISTICS

Operating Voltage, U _o /U:	300/500V
Operating Temperature:	-15°C to 90°C
Final Short Circuit Temperature:	250°C
Test Voltage:	2kV for 1 minute

REFERENCE STANDARDS

Design Specification:	BS EN50288-7
Conductor:	IEC60228, BS EN60228
Fire Resistance:	BS6387 (C, W, Z), SS299 (C, W, Z), IEC60331
Flame Retardancy:	IEC60332-3-22, BS EN60332-3-22
Low Smoke Zero Halogen:	IEC61034-2, BS EN61034-2 IEC60754-1, IEC60754-2 BS EN50267-2-1, BS EN50267-2-2

INSTALLATION REFERENCE

Min. Bending Radius (mm):	8 x cable overall diameter
Max. Pulling Tension (N/mm ²):	50

	No. of Pairs	Nominal Conductor Area (mm ²)	No. and Diameter of Wires (no./mm)	Radial Thickness of Insulation (mm)	Cable Overall Diameter (mm)	Approximate Weight (kg/km)
SINGLE PAIR	1P	1.0	7 / 0.43	0.6	10.0	98
	1P	1.5	7 / 0.53	0.6	10.6	113
	1P	2.5	7 / 0.67	0.7	12.0	150

Note: Class 5 conductors are available upon request.

Table 58

APPENDIX A

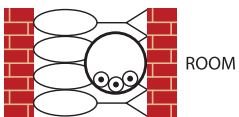
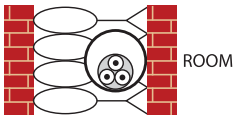
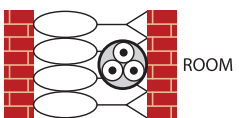
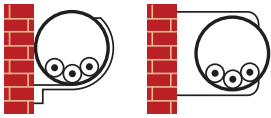
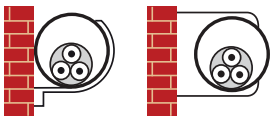

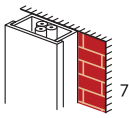

Table A1.1

Schedule of Installation Methods of cables (including Reference Methods) for determining current-carrying capacity



NOTE 1: The illustrations are not intended to depict actual product or installation practices but are indicative of the method described.

NOTE 2: The installation and reference methods stated are in line with IEC. However, not all methods have a corresponding rating for all cable types.

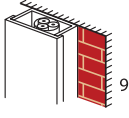
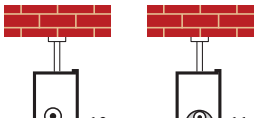
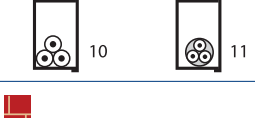
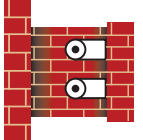
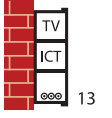
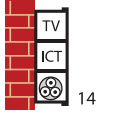
Installation Method		Reference Method to be used to determine current-carrying capacity	
Number	Examples	Description	
1		Non-sheathed cables in conduit in a thermally insulated wall with an inner skin having a thermal conductance of not less than 10 W/m ² k	A
2		Multicore cable in conduit in a thermally insulated wall with an inner skin having a thermal conductance of not less than 10 W/m ² k	A
3		Multicore cable direct in a thermally insulated wall with an inner skin having a thermal conductance of not less than 10 W/m ² k	A
4		Non-sheathed cables in conduit on a wooden or masonry wall or spaced less than 0.3 x conduit diameter from it ^c	B
5		Multicore cable in conduit on a wooden or masonry wall or spaced less than 0.3 x conduit diameter from it ^c	B
6		Non-sheathed cables in cable trunking on a wooden or masonry wall 6 - run horizontally ^b 7 - run vertically ^{b, c}	B
7			
8		Multicore cable in cable trunking on a wooden or masonry wall 8 - run horizontally ^b 9 - run vertically ^{b, c}	B*
9			
10		Non-sheathed cables in suspended cable trunking ^b	B
11		Multicore cable in suspended cable trunking ^b	B
12		Non-sheathed cables run in mouldings ^{c, e}	A
13		Non-sheathed cables in skirting trunking	B
14		Multicore cable in skirting trunking	B

^b Values given for Installation Method B in Appendix A are for a single circuit. Where there is more than one circuit in the trunking the group rating factor given in Table C2.1 is applicable, irrespective of the presence of an internal barrier or partition.

^c Care is needed where the cable runs vertically and ventilation is restricted. The ambient temperature at the top of the vertical section can be much higher.

^e The thermal resistivity of the enclosure is assumed to be poor because of the material of construction and possible air spaces. Where the construction is thermally equivalent to Installation Methods 6 or 7, Reference Method B may be used.

* Still under consideration in IEC.

APPENDIX A

Table A1.2

Schedule of Installation Methods of cables (including Reference Methods) for determining current-carrying capacity



NOTE 1: The illustrations are not intended to depict actual product or installation practices but are indicative of the method described.

NOTE 2: The installation and reference methods stated are in line with IEC. However, not all methods have a corresponding rating for all cable types.

Number	Examples	Installation Method	Description	Reference Method to be used to determine current-carrying capacity
20			Single-core or multicore cables: Fixed on (clipped direct), or spaced less than 0.3 x cable diameter from a wooden or masonry wall ^c	C
21			Single-core or multicore cables: Fixed directly under wooden or masonry ceiling	B <i>(Higher than standard ambient temperatures may occur with this installation method)</i>
22			Single-core or multicore cables: Spaced from a ceiling	E, F or G* <i>(Higher than standard ambient temperatures may occur with this installation method)</i>
30			Single-core or multicore cables: On unperforated tray run horizontally or vertically ^{c,h}	C with item 2 of Table C2.1
31			Single-core or multicore cables: On unperforated tray run horizontally or vertically ^{c,h}	E or F
32			Single-core or multicore cables: On brackets or on a wire mesh tray run horizontally or vertically ^{c,h}	E or F
33			Single-core or multicore cables: Spaced more than 0.3 x the cable diameter from a wall	E, F or G ^g
34			Single-core or multicore cables: On a ladder ^c	E or F
35			Single-core or multicore cable suspended from or incorporating a support wire or harness	E or F

^c Care is needed where the cable runs vertically and ventilation is restricted. The ambient temperature at the top of the vertical section can be much higher.

^f The thermal resistivity of the enclosure is assumed to be poor because of the material of construction and possible air spaces. Where the construction is thermally equivalent to Installation Methods 6, 7, 8 or 9. Reference Method B may be used.

^g The factor in Table C2.1 may also be used.

^h D_e = the external diameter of a multicore cable:
– 2.2 x the cable diameter when three single-core cables are bound in trefoil, or
– 3 x the cable diameter when three single-core cables are laid in flat formation.

* Still under consideration in IEC.

APPENDIX A

Table A1.3

Schedule of Installation Methods of cables (including Reference Methods) for determining current-carrying capacity



NOTE 1: The illustrations are not intended to depict actual product or installation practices but are indicative of the method described.

NOTE 2: The installation and reference methods stated are in line with IEC. However, not all methods have a corresponding rating for all cable types.

Number	Examples	Installation Method	Description	Reference Method to be used to determine current-carrying capacity
36		Bare or non-sheathed cables on insulators		G
40		Single-core or multicore cables: In a building void ^{c, h, i}		Where $1.5 D_e \leq V \leq 20 D_e$ Use B
41		Non-sheathed cables: - In conduit - In a building void - In masonry having a thermal resistivity not greater than 2 K.m/W ^{c, i, j}		Where $1.5 D_e \leq V$ Use B
42		Single-core or multicore cables: - In conduit - In a building void - In masonry having a thermal resistivity not greater than 2 K.m/W ^{c, j}		Where $1.5 D_e \leq V$ Use B
43		Non-sheathed cables: - In cable ducting - In a building void - In masonry having a thermal resistivity not greater than 2 K.m/W ^{c, i, j}		Where $1.5 D_e \leq V$ Use B
44		Single-core or multicore cables: - In cable ducting - In a building void - In masonry having a thermal resistivity not greater than 2 K.m/W ^{c, i, j}		Where $1.5 D_e \leq V$ Use B
45		Non-sheathed cables: - In cable ducting - In masonry having a thermal resistivity not greater than 2 K.m/W ^{c, h, i}		Where $1.5 D_e \leq V \leq 50 D_e$ Use B
46		Single-core or multicore cables: - In cable ducting - In masonry having a thermal resistivity not greater than 2 K.m/W ^{c, h, i}		Where $1.5 D_e \leq V \leq 50 D_e$ Use B
47		Single-core or multicore cables: - In a ceiling void - In a suspended floor ^{h, i}		Where $1.5 D_e \leq V \leq 50 D_e$ Use B
50		Non-sheathed cables in flush cable trunking in the floor		B

c Care is needed where the cable runs vertically and ventilation is restricted. The ambient temperature at the top of the vertical section can be much higher.

g The factors in table C2.1 may also be used.

h D_e = the external diameter of a multicore cable:
- $2.2 \times$ the cable diameter when three single-core cables are bound in trefoil, or
- $3 \times$ the cable diameter when three single-core cables are laid in flat formation.

i V = the smaller dimension or diameter of a masonry duct or void, or the vertical depth of a rectangular duct, floor or ceiling void or channel.

j D_e = external diameter of conduit or vertical depth of cable ducting.

APPENDIX A

Table A1.4

Schedule of Installation Methods of cables (including Reference Methods) for determining current-carrying capacity



NOTE 1: The illustrations are not intended to depict actual product or installation practices but are indicative of the method described.

NOTE 2: The installation and reference methods stated are in line with IEC. However, not all methods have a corresponding rating for all cable types.

Number	Examples	Installation Method	Description	Reference Method to be used to determine current-carrying capacity
51			Multicore cable in flush cable trunking in the floor	B
52			Non-sheathed cables in flush trunking ^c	B
53			Multicore cable in flush trunking ^c	B
54			Non-sheathed cables or single-core cables in conduit in an unventilated cable channel run horizontally or vertically ^{c, i, k, m}	Where $1.5 D_e \leq V$ Use B
55			Non-sheathed cables in conduit in an open or ventilated cable channel in the floor ^{l, m}	B
56			Sheathed single-core or multicore cable in an open or ventilated cable channel run horizontally or vertically ^m	B
57			Single-core or multicore cable direct in masonry having a thermal resistivity not greater than 2 K.m/W - Without added mechanical protection ^{n, o}	C
58			Single-core or multicore cable direct in masonry having a thermal resistivity not greater than 2 K.m/W - With added mechanical protection ^{n, o} (e.g. capping)	C
59			Non-sheathed cables or single-core cables in conduit in masonry having a thermal resistivity not greater than 2 K.m/W ^o	B
60			Multicore cables in conduit in masonry having a thermal resistivity not greater than 2 K.m/W ^o	B

^c Care is needed where the cable runs vertically and ventilation is restricted. The ambient temperature at the top of the vertical section can be much higher.

^k D_e = external diameter of conduit.

ⁱ V = the smaller dimension or diameter of a masonry duct or void, or the vertical depth of a rectangular duct, floor or ceiling void or channel. The depth of the channel is more important than the width.

^l For multicore cable installed as method 55, use current-carrying capacity for Reference Method B.

^m It is recommended that these installation methods are used only in areas where access is restricted to authorized persons so that the reduction in current-carrying capacity and the fire hazard due to the accumulation of debris can be prevented.

ⁿ For cables having conductors not greater than 16mm², the current carrying capacity may be higher.

^o Thermal resistivity of masonry is not greater than 2 K.m/W. The term masonry is taken to include brickwork, concrete, plaster and the like (excludes thermally insulating materials).

APPENDIX A



Table A1.5

Schedule of Installation Methods of cables (including Reference Methods) for determining current-carrying capacity



NOTE 1: The illustrations are not intended to depict actual product or installation practices but are indicative of the method described.

NOTE 2: The installation and reference methods stated are in line with IEC. However, not all methods have a corresponding rating for all cable types.

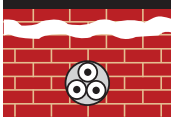
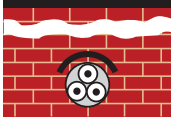
Number	Examples	Description	Reference Method to be used to determine current-carrying capacity
70		Multicore unarmoured cable in conduit or in cable ducting in the ground	D
71		Single-core unarmoured cable in conduit or in cable ducting in the ground	D
72		Sheathed, armoured or multicore cables direct in the ground – Without added mechanical protection (see note)	D
73		Sheathed, armoured or multicore cables direct in the ground – With added mechanical protection (eg. cable covers) (see note)	D

Note: The inclusion of directly buried cables is satisfactory where the soil thermal resistivity is of the order of 2.5K.m/W. For lower soil resistivities, the current-carrying capacity for directly buried cables is appreciably higher than for cables in ducts.

APPENDIX B

Current Carrying Capacity (IN AMPERES)

Table B1.1: Single-core copper conductor, 70°C PVC insulated, non-armoured, with or without sheathed cables, Ambient air temperature: 30°C, Ambient ground temperature: 20°C, Soil thermal resistivity (cable buried in ground): 2.5K.m/W

BS 6004
BS 6231
SS 358
IEC 60227
IEC 60502-1



Conductor Cross-Sectional Area mm ²	Reference Method A (enclosed in conduit in thermally insulating wall etc)		Reference Method B (enclosed in conduit on wall or in trunking etc)		Reference Method C (clipped direct)		Reference Method F (in free air or on a perforated cable tray horizontal or vertical)				
	2 Cables, Single-Phase a.c. or d.c.	3 or 4 Cables, 3-Phase a.c.	2 Cables, Single-Phase a.c. or d.c.	3 or 4 Cables, 3-Phase a.c.	2 Cables, Single-Phase a.c. or d.c. Flat and Touching	3 or 4 Cables, 3-Phase a.c. Flat and Touching or Trefoil	Touching			Spaced by One Cable Diameter	
							2 Cables, Single-Phase a.c. or d.c. Flat	3 Cables, 3-Phase a.c. Flat	3 Cables, 3-Phase a.c. Trefoil	2 Cables, Single-Phase a.c. or d.c., or 3 Cables, 3-Phase a.c. Flat	
	A	A	A	A	A	A	A	A	A	Horizontal	Vertical
1.0	11	10.5	13.5	12	15.5	14	-	-	-	-	-
1.5	14.5	13.5	17.5	15.5	20	18	-	-	-	-	-
2.5	20	18	24	21	27	25	-	-	-	-	-
4	26	24	32	28	37	33	-	-	-	-	-
6	34	31	41	36	47	43	-	-	-	-	-
10	46	42	57	50	65	59	-	-	-	-	-
16	61	56	76	68	87	79	-	-	-	-	-
25	80	73	101	89	114	104	131	114	110	146	130
35	99	89	125	110	141	129	162	143	137	181	162
50	119	108	151	134	182	167	196	174	167	219	197
70	151	136	192	171	234	214	251	225	216	281	254
95	182	164	232	207	284	261	304	275	264	341	311
120	210	188	269	239	330	303	352	321	308	396	362
150	240	216	300	262	381	349	406	372	356	456	419
185	273	245	341	296	436	400	463	427	409	521	480
240	321	286	400	346	515	472	546	507	485	615	569
300	367	328	458	394	594	545	629	587	561	709	659
400	-	-	546	467	694	634	754	689	656	852	795
500	-	-	626	533	792	723	868	789	749	982	920
630	-	-	720	611	904	826	1005	905	855	1138	1070
800	-	-	-	-	1030	943	1086	1020	971	1265	1188
1000	-	-	-	-	1154	1058	1216	1149	1079	1420	1337

Voltage Drop (IN mV/A/m)

Table B2.1: Single-core copper conductor, 70°C PVC insulated, non-armoured, with or without sheathed cables, Ambient air temperature: 30°C, Conductor operating temperature: 70°C

Conductor Cross-Sectional Area mm ²	2 Cables d.c. mV/A/m	2 Cables, Single-Phase a.c.						3 or 4 Cables, 3-Phase a.c.														
		Reference Methods A & B (enclosed in conduit or trunking)		Reference Methods C & F (clipped direct, on tray or in free air)				Reference Methods A & B (enclosed in conduit or trunking)	Reference Methods C & F (clipped direct, on tray or in free air)													
		mV/A/m		Cables Touching		Cables Spaced*			Cables Touching, Trefoil		Cables Touching, Flat		Cables Spaced*, Flat									
		mV/A/m	mV/A/m	mV/A/m	mV/A/m	mV/A/m	mV/A/m	mV/A/m	mV/A/m	mV/A/m	mV/A/m	mV/A/m	mV/A/m	mV/A/m								
1.0	44	44	44	44	44	44	38	38	38	38	38	38	38									
1.5	29	29	29	29	29	29	25	25	25	25	25	25	25									
2.5	18	18	18	18	18	18	15	15	15	15	15	15	15									
4	11	11	11	11	11	11	9.5	9.5	9.5	9.5	9.5	9.5	9.5									
6	7.3	7.3	7.3	7.3	7.3	7.3	6.4	6.4	6.4	6.4	6.4	6.4	6.4									
10	4.4	4.4	4.4	4.4	4.4	4.4	3.8	3.8	3.8	3.8	3.8	3.8	3.8									
16	2.8	2.8	2.8	2.8	2.8	2.8	2.4	2.4	2.4	2.4	2.4	2.4	2.4									
		r	x	z	r	x	z	r	x	z	r	x	z	r	x	z	r	x	z	r	x	z
25	1.75	1.80	0.33	1.80	1.75	0.20	1.75	1.75	0.29	1.80	1.50	0.29	1.55	1.50	0.175	1.50	1.50	0.25	1.55	1.50	0.32	1.55
35	1.25	1.30	0.31	1.30	1.25	0.195	1.25	1.25	0.28	1.30	1.10	0.27	1.10	1.10	0.170	1.10	1.10	0.24	1.10	1.10	0.32	1.15
50	0.93	0.95	0.30	1.00	0.93	0.190	0.95	0.93	0.28	0.97	0.81	0.26	0.85	0.80	0.165	0.82	0.80	0.24	0.84	0.80	0.32	0.86
70	0.63	0.65	0.29	0.72	0.63	0.185	0.66	0.63	0.27	0.69	0.56	0.25	0.61	0.55	0.160	0.57	0.55	0.24	0.60	0.55	0.31	0.63
95	0.46	0.49	0.28	0.56	0.47	0.180	0.50	0.47	0.27	0.54	0.42	0.24	0.48	0.41	0.155	0.43	0.41	0.23	0.47	0.40	0.31	0.51
120	0.36	0.39	0.27	0.47	0.37	0.175	0.41	0.37	0.26	0.45	0.33	0.23	0.41	0.32	0.150	0.36	0.32	0.23	0.40	0.32	0.30	0.44
150	0.29	0.31	0.27	0.41	0.30	0.175	0.34	0.29	0.26	0.39	0.27	0.23	0.36	0.26	0.150	0.30	0.26	0.23	0.34	0.26	0.30	0.40
185	0.23	0.25	0.27	0.37	0.24	0.170	0.29	0.24	0.26	0.35	0.22	0.23	0.32	0.21	0.145	0.26	0.21	0.22	0.31	0.21	0.30	0.36
240	0.180	0.195	0.26	0.33	0.185	0.165	0.25	0.185	0.25	0.31	0.17	0.23	0.29	0.160	0.145	0.22	0.160	0.22	0.27	0.160	0.29	0.34
300	0.145	0.160	0.29	0.31	0.150	0.165	0.22	0.150	0.25	0.29	0.14	0.23	0.27	0.130	0.140	0.190	0.130	0.22	0.25	0.130	0.29	0.32
400	0.105	0.130	0.26	0.29	0.120	0.160	0.20	0.115	0.25	0.27	0.12	0.22	0.25	0.105	0.140	0.175	0.105	0.21	0.24	0.100	0.29	0.31
500	0.086	0.110	0.26	0.28	0.098	0.155	0.185	0.093	0.24	0.26	0.10	0.22	0.25	0.086	0.135	0.160	0.086	0.21	0.23	0.081	0.29	0.30
630	0.068	0.094	0.25	0.27	0.081	0.155	0.175	0.076	0.24	0.25	0.08	0.22	0.24	0.072	0.135	0.150	0.072	0.21	0.22	0.066	0.28	0.29
800	0.053	-	-	-	0.068	0.150	0.165	0.061	0.24	0.25	-	-	-	0.060	0.130	0.145	0.060	0.21	0.22	0.053	0.28	0.29
1000	0.042	-	-	-	0.059	0.150	0.160	0.050	0.24	0.24	-	-	-	0.052	0.130	0.140	0.052	0.20	0.21	0.044	0.28	0.28

Note: *Spacings larger than one cable diameter will result in a larger voltage drop.

APPENDIX B

Current Carrying Capacity (IN AMPERES)

Table B1.2: Multi-core, 70°C PVC insulated, PVC sheathed non-armoured cables

Ambient air temperature: 30°C, Ambient ground temperature: 20°C, Soil thermal resistivity (cable buried in ground): 2.5K.m/W

BS 6346
IEC60502-1



Conductor Cross-Sectional Area	Reference Method A (enclosed in conduit in thermally insulating wall etc)		Reference Method B (enclosed in conduit on a wall or in trunking etc)		Reference Method C (clipped direct)		Reference Method E (in free air or on a perforated cable tray horizontal or vertical)	
	One 2-Core Cable*, Single-Phase a.c. or d.c.	One 3-Core Cable* or One 4-Core Cable, 3-Phase a.c.	One 2-Core Cable*, Single-Phase a.c. or d.c.	One 3-core Cable* or One 4-Core Cable, 3-Phase a.c.	One 2-Core Cable*, Single-Phase a.c. or d.c.	One 3-Core Cable* or One 4-Core Cable, 3-Phase a.c.	One 2-Core Cable*, Single-Phase a.c. or d.c.	One 3-Core Cable* or One 4-Core Cable, 3-Phase a.c.
mm ²	A	A	A	A	A	A	A	A
1.0	11	10	13	11.5	15	13.5	17	14.5
1.5	14	13	16.5	15	19.5	17.5	22	18.5
2.5	18.5	17.5	23	20	27	24	30	25
4	25	23	30	27	36	32	40	34
6	32	29	38	34	46	41	51	43
10	43	39	52	46	63	57	70	60
16	57	52	69	62	85	76	94	80
25	75	68	90	80	112	96	119	101
35	92	83	111	99	138	119	148	126
50	110	99	133	118	168	144	180	153
70	139	125	168	149	213	184	232	196
95	167	150	201	179	258	223	282	238
120	192	172	232	206	299	259	328	276
150	219	196	258	225	344	299	379	319
185	248	223	294	255	392	341	434	364
240	291	261	344	297	461	403	514	430
300	334	298	394	339	530	464	593	497
400	-	-	470	402	634	557	715	597

*With or without a protective conductor.

Voltage Drop (IN mV/A/m)

Table B2.2: Multi-core 70°C PVC insulated, PVC sheathed non-armoured cables

Ambient temperature: 30°C, Conductor operating temperature: 70°C

Conductor Cross-Sectional Area	2-Core Cable, d.c.		2-Core Cable, Single-Phase a.c.			3 or 4 Core Cable, 3-Phase a.c.		
	mm ²	mV/A/m	r	x	z	r	x	z
1.0	44	44	44			38		
1.5	29	29	29			25		
2.5	18	18	18			15		
4	11	11	11			9.5		
6	7.3	7.3	7.3			6.4		
10	4.4	4.4	4.4			3.8		
16	2.8	2.8	2.8			2.4		
25	1.75	1.75	1.75	0.170	1.75	1.50	0.145	1.50
35	1.25	1.25	1.25	0.165	1.25	1.10	0.145	1.10
50	0.93	0.93	0.93	0.165	0.94	0.80	0.140	0.81
70	0.63	0.63	0.63	0.160	0.65	0.55	0.140	0.57
95	0.46	0.47	0.47	0.155	0.50	0.41	0.135	0.43
120	0.36	0.38	0.38	0.155	0.41	0.33	0.135	0.35
150	0.29	0.30	0.30	0.155	0.34	0.26	0.130	0.29
185	0.23	0.25	0.25	0.150	0.29	0.21	0.130	0.25
240	0.180	0.190	0.190	0.150	0.24	0.165	0.130	0.21
300	0.145	0.155	0.155	0.145	0.21	0.135	0.130	0.185
400	0.105	0.115	0.115	0.145	0.185	0.100	0.125	0.160

Note: *Spacings larger than one cable diameter will result in a larger voltage drop.



Current Carrying Capacity (IN AMPERES)

Table B1.3: Single-core 70°C PVC insulated, PVC sheathed armoured cables (non-magnetic armour)

Ambient air temperature: 30°C, Ambient ground temperature: 20°C, Soil thermal resistivity (cable buried in ground): 2.5K.m/W

Conductor Cross-Sectional Area	Reference Method C (clipped direct)			Reference Method F (in free air or on a perforated cable tray horizontal or vertical)							
	Touching		Touching			Spaced by One Cable Diameter					
	2 Cables, Single-Phase a.c. or d.c. flat	3 or 4 Cables, 3-Phase a.c. flat	2 Cables, Single-Phase a.c. or d.c. flat	3 Cables, 3-Phase a.c. flat	3 Cables, 3-Phase a.c. trefoil	2 Cables, d.c.		2 Cables, Single-Phase a.c.		3 or 4 Cables, 3-Phase a.c.	
	A	A	A	A	A	Horizontal	Vertical	Horizontal	Vertical	Horizontal	Vertical
50	193	179	205	189	181	229	216	229	217	230	212
70	245	225	259	238	231	294	279	287	272	286	263
95	296	269	313	285	280	357	340	349	332	338	313
120	342	309	360	327	324	415	396	401	383	385	357
150	393	352	413	373	373	479	458	449	429	436	405
185	447	399	469	422	425	548	525	511	489	490	456
240	525	465	550	492	501	648	622	593	568	566	528
300	594	515	624	547	567	748	719	668	640	616	578
400	687	575	723	618	657	885	851	737	707	674	632
500	763	622	805	673	731	1035	997	810	777	721	676
630	843	669	891	728	809	1218	1174	893	856	771	723
800	919	710	976	777	886	1441	1390	943	905	824	772
1000	975	737	1041	808	945	1685	1627	1008	967	872	816

Voltage Drop (IN mV/A/m)

Table B2.3: Single-core 70°C PVC insulated, PVC sheathed armoured cables (non-magnetic armour)

Ambient temperature: 30°C, Conductor operating temperature: 70°C

Conductor Cross-Sectional Area	2 Cables, d.c.	Reference Method C & F (clipped direct, on tray or free air)														
		2 Cables, Single-Phase a.c.						3 or 4 Cables, 3-Phase a.c.								
		Touching			Spaced*			Trefoil and Touching			Flat and Touching			Flat and Spaced*		
		mV/A/m	mV/A/m	mV/A/m	mV/A/m	mV/A/m	mV/A/m	mV/A/m	mV/A/m	mV/A/m	mV/A/m	mV/A/m	mV/A/m	mV/A/m	mV/A/m	mV/A/m
50	0.93	r	x	z	r	x	z	r	x	z	r	x	z	r	x	z
70	0.63	0.93	0.22	0.95	0.92	0.30	0.97	0.80	0.190	0.82	0.79	0.26	0.84	0.79	0.34	0.86
95	0.46	0.64	0.21	0.68	0.66	0.29	0.72	0.56	0.180	0.58	0.57	0.25	0.62	0.59	0.32	0.68
120	0.36	0.48	0.20	0.52	0.51	0.28	0.58	0.42	0.175	0.45	0.44	0.25	0.50	0.47	0.31	0.57
150	0.29	0.39	0.195	0.43	0.42	0.28	0.50	0.33	0.170	0.37	0.36	0.24	0.43	0.40	0.30	0.50
185	0.23	0.31	0.190	0.37	0.34	0.27	0.44	0.27	0.165	0.32	0.30	0.24	0.38	0.34	0.30	0.45
240	0.180	0.26	0.190	0.32	0.29	0.27	0.39	0.22	0.160	0.27	0.25	0.23	0.34	0.29	0.29	0.41
300	0.145	0.20	0.180	0.27	0.23	0.26	0.35	0.175	0.160	0.23	0.20	0.23	0.30	0.24	0.28	0.37
400	0.105	0.160	0.180	0.24	0.190	0.26	0.32	0.140	0.155	0.21	0.165	0.22	0.28	0.20	0.28	0.34
500	0.086	0.140	0.175	0.22	0.180	0.24	0.30	0.120	0.130	0.195	0.160	0.21	0.26	0.21	0.25	0.32
630	0.068	0.120	0.170	0.21	0.165	0.23	0.29	0.105	0.145	0.180	0.145	0.20	0.25	0.190	0.24	0.30
800	0.053	0.105	0.165	0.195	0.150	0.22	0.27	0.091	0.145	0.170	0.135	0.195	0.23	0.175	0.22	0.28
1000	0.042	0.095	0.160	0.185	0.145	0.21	0.25	0.082	0.140	0.160	0.125	0.180	0.22	0.170	0.195	0.26
		0.091	0.155	0.180	0.140	0.190	0.24	0.079	0.135	0.155	0.125	0.165	0.21	0.165	0.170	0.24

Note: *Spacings larger than one cable diameter will result in a larger voltage drop.



Current Carrying Capacity (IN AMPERES)

Table B1.4: Multi-core 70°C PVC insulated, PVC sheathed armoured cables

Ambient air temperature: 30°C, Ambient ground temperature: 20°C, Soil thermal resistivity (cable buried in ground): 2.5K.m/W

Conductor Cross-Sectional Area mm ²	Reference Method C (dipped direct)		Reference Method E (in free air or on a perforated cable tray etc, horizontal or vertical)		Reference Method D (direct in ground or in ducting in ground, in or around buildings)	
	One 2-Core Cable, Single-Phase a.c. or d.c.	One 3 or 4-Core Cable, 3-Phase a.c.	One 2-Core Cable, Single-Phase a.c. or d.c.	One 3 or 4-Core Cable, 3-Phase a.c.	One 2-Core Cable, Single-Phase a.c. or d.c.	One 3 or 4-Core Cable, 3-Phase a.c.
	A	A	A	A	A	A
1.5	21	18	22	19	22	18
2.5	28	25	31	26	29	24
4	38	33	41	35	37	30
6	49	42	53	45	46	38
10	67	58	72	62	60	50
16	89	77	97	83	78	64
25	118	102	128	110	99	82
35	145	125	157	135	119	98
50	175	151	190	163	140	116
70	222	192	241	207	173	143
95	269	231	291	251	204	169
120	310	267	336	290	231	192
150	356	306	386	332	261	217
185	405	348	439	378	292	243
240	476	409	516	445	336	280
300	547	469	592	510	379	316
400	621	540	683	590	-	-

Voltage Drop (IN mV/A/m)

Table B2.4: Multi-core 70°C PVC insulated, PVC sheathed armoured cables

Ambient temperature: 30°C, Conductor operating temperature: 70°C

Conductor Cross-Sectional Area mm ²	2-Core Cable, d.c.	2-Core Cable, Single-Phase a.c.			3 or 4-Core Cable, 3-Phase a.c.		
	mV/A/m	r	x	z	r	x	z
1.5	29	1.75	0.170	1.75	1.50	0.145	1.50
2.5	18	1.25	0.165	1.25	1.10	0.145	1.10
4	11	0.93	0.165	0.94	0.80	0.140	0.81
6	7.3	0.63	0.160	0.65	0.55	0.140	0.57
10	4.4	0.47	0.155	0.50	0.41	0.135	0.43
16	2.8	0.38	0.155	0.41	0.33	0.135	0.35
25	1.75	0.30	0.155	0.34	0.26	0.130	0.29
35	1.25	0.25	0.150	0.29	0.21	0.130	0.25
50	0.93	0.190	0.150	0.24	0.165	0.130	0.21
70	0.63	0.155	0.145	0.21	0.135	0.130	0.185
95	0.46	0.115	0.145	0.185	0.100	0.125	0.160
120	0.36						
150	0.29						
185	0.23						
240	0.180						
300	0.145						
400	0.105						

Note: *Spacings larger than one cable diameter will result in a larger voltage drop.

APPENDIX B

Current Carrying Capacity (IN AMPERES)

Table B1.5: Single-core 90°C XLPE / Cross-Linked LSZH / EPR insulated, unarmoured, with or without sheath (PVC / LSZH) cables

Ambient air temperature: 30°C, Ambient ground temperature: 20°C, Soil thermal resistivity (cable buried in ground): 2.5K.m/W

IEC 60502-1
BS 7211
*based on
600/1000V
application
BS 7889



Conductor Cross-Sectional Area	Reference Method A (enclosed in conduit in thermally insulating wall etc)		Reference Method B (enclosed in conduit on a wall or in trunking etc)		Reference Method C (clipped direct)		Reference Method F (in free air or on a perforated cable tray etc, horizontal or vertical etc)			Reference Method G (in free air)	
	2 Cables, Single-Phase a.c. or d.c.	3 or 4 Cables, 3-Phase a.c.	2 Cables, Single-Phase a.c. or d.c.	3 or 4 Cables, 3-Phase a.c.	2 Cables, Single-Phase a.c. or d.c. Flat and Touching	3 or 4 Cables, 3-Phase a.c. Flat and Touching or Trefoil	Touching			Spaced by One Cable Diameter	
	A	A	A	A	A	A	2 Cables, Single-Phase a.c. or d.c. Flat	3 Cables, 3-Phase a.c. Flat	3 Cables, 3-Phase a.c. Trefoil	2 Cables, Single-Phase a.c. or d.c., or 3 Cables, 3-Phase a.c. Flat	Horizontal
mm ²	A	A	A	A	A	A	A	A	A	A	A
1.0	14	13	17	15	19	17.5	-	-	-	-	-
1.5	19	17	23	20	25	23	-	-	-	-	-
2.5	26	23	31	28	34	31	-	-	-	-	-
4	35	31	42	37	46	41	-	-	-	-	-
6	45	40	54	48	59	54	-	-	-	-	-
10	61	54	75	66	81	74	-	-	-	-	-
16	81	73	100	88	109	99	-	-	-	-	-
25	106	95	133	117	143	130	161	141	135	182	161
35	131	117	164	144	176	161	200	176	169	226	201
50	158	141	198	175	228	209	242	216	207	275	246
70	200	179	253	222	293	268	310	279	268	353	318
95	241	216	306	269	355	326	377	342	328	430	389
120	278	249	354	312	413	379	437	400	383	500	454
150	318	285	393	342	476	436	504	464	444	577	527
185	362	324	449	384	545	500	575	533	510	661	605
240	424	380	528	450	644	590	679	634	607	781	719
300	486	435	603	514	743	681	783	736	703	902	833
400	-	-	683	584	868	793	940	868	823	1085	1008
500	-	-	783	666	990	904	1083	998	946	1253	1169
630	-	-	900	764	1130	1033	1254	1151	1088	1454	1362
800	-	-	-	-	1288	1179	1358	1275	1214	1581	1485
1000	-	-	-	-	1443	1323	1520	1436	1349	1775	1671

Note: 1. Where a conductor operates at a temperature exceeding 70°C it must be ascertained that the equipment connected to the conductor is suitable for the conductor operating temperature.
2. Where cables in this table are connected to equipment or accessories designed to operate at a temperature not exceeding 70°C, the current ratings given in the equivalent table for 70°C thermoplastic insulated cables must be used.

Voltage Drop (IN mV/A/m)

Table B2.5: Single-core 90°C XLPE / Cross-Linked LSZH / EPR insulated, unarmoured, with or without sheath (PVC / LSZH) cables
Ambient temperature: 30°C, Conductor operating temperature: 90°C

Conductor Cross-Sectional Area	2 Cables, Single-Phase a.c.					3 or 4 Cables, 3-Phase a.c.																
	2 Cables d.c.	Reference Methods A & B (enclosed in conduit or trunking)			Reference Methods C, F & G (clipped direct, on tray or in free air)		Reference Methods A & B (enclosed in conduit or trunking)	Reference Methods C, F & G (clipped direct, on tray or in free air)														
		mV/A/m	r	x	z	mV/A/m		mV/A/m	Cables Touching, Trefoil			Cables Touching, Flat			Cables Spaced*, Flat							
mm ²	mV/A/m	mV/A/m	mV/A/m	mV/A/m	mV/A/m	mV/A/m	mV/A/m	mV/A/m	mV/A/m	mV/A/m	mV/A/m	mV/A/m	mV/A/m	mV/A/m	mV/A/m	mV/A/m	mV/A/m	mV/A/m				
1.0	46	46	46	46	46	40	40	40	40	40	40	40	40	40	40	40	40	40				
1.5	31	31	31	31	31	27	27	27	27	27	27	27	27	27	27	27	27	27				
2.5	19	19	19	19	19	16	16	16	16	16	16	16	16	16	16	16	16	16				
4	12	12	12	12	12	10	10	10	10	10	10	10	10	10	10	10	10	10				
6	7.9	7.9	7.9	7.9	7.9	6.8	6.8	6.8	6.8	6.8	6.8	6.8	6.8	6.8	6.8	6.8	6.8	6.8				
10	4.7	4.7	4.7	4.7	4.7	4.0	4.0	4.0	4.0	4.0	4.0	4.0	4.0	4.0	4.0	4.0	4.0	4.0				
16	2.9	2.9	2.9	2.9	2.9	2.5	2.5	2.5	2.5	2.5	2.5	2.5	2.5	2.5	2.5	2.5	2.5	2.5				
25	1.85	1.85	0.31	1.90	1.85	0.190	1.85	1.85	0.28	1.85	1.60	0.27	1.65	1.60	0.165	1.60	1.60	0.190	1.60	1.60	0.27	1.65
35	1.35	1.35	0.29	1.35	1.35	0.180	1.35	1.35	0.27	1.35	1.15	0.25	1.15	1.15	0.155	1.15	1.15	0.180	1.15	1.15	0.26	1.20
50	0.99	1.00	0.29	1.05	0.99	0.180	1.00	0.99	0.27	1.00	0.87	0.25	0.90	0.86	0.155	0.87	0.86	0.180	0.87	0.86	0.26	0.89
70	0.68	0.70	0.28	0.75	0.68	0.175	0.71	0.68	0.26	0.73	0.60	0.24	0.65	0.59	0.150	0.61	0.59	0.175	0.62	0.59	0.25	0.65
95	0.49	0.51	0.27	0.58	0.49	0.170	0.52	0.49	0.26	0.56	0.44	0.23	0.50	0.43	0.145	0.45	0.43	0.170	0.46	0.43	0.25	0.49
120	0.39	0.41	0.26	0.48	0.39	0.165	0.43	0.39	0.25	0.47	0.35	0.23	0.42	0.34	0.140	0.37	0.34	0.165	0.38	0.34	0.24	0.42
150	0.32	0.33	0.26	0.43	0.32	0.165	0.36	0.32	0.25	0.41	0.29	0.23	0.37	0.28	0.140	0.31	0.28	0.165	0.32	0.28	0.24	0.37
185	0.25	0.27	0.26	0.37	0.26	0.165	0.30	0.25	0.25	0.36	0.23	0.23	0.32	0.22	0.140	0.26	0.22	0.165	0.28	0.22	0.24	0.33
240	0.190	0.21	0.26	0.33	0.20	0.160	0.25	0.195	0.25	0.31	0.185	0.22	0.29	0.170	0.140	0.22	0.170	0.165	0.24	0.17	0.24	0.29
300	0.155	0.175	0.25	0.31	0.160	0.160	0.22	0.155	0.25	0.29	0.150	0.22	0.27	0.140	0.140	0.195	0.135	0.160	0.21	0.135	0.24	0.27
400	0.120	0.140	0.25	0.29	0.130	0.155	0.20	0.125	0.24	0.27	0.125	0.22	0.25	0.110	0.135	0.175	0.110	0.160	0.195	0.110	0.24	0.26
500	0.093	0.120	0.25	0.28	0.105	0.155	0.185	0.098	0.24	0.26	0.100	0.22	0.24	0.090	0.135	0.160	0.088	0.160	0.180	0.085	0.24	0.25
630	0.072	0.100	0.25	0.27	0.086	0.155	0.175	0.078	0.24	0.25	0.088	0.21	0.23	0.074	0.135	0.150	0.071	0.160	0.170	0.068	0.23	0.24
800	0.056	-	-	-	0.072	0.150	0.170	0.064	0.24	0.25	-	-	-	0.062	0.130	0.145	0.059	0.155	0.165	0.055	0.23	0.24
1000	0.045	-	-	-	0.063	0.150	0.165	0.054	0.24	0.24	-	-	-	0.055	0.130	0.140	0.050	0.155	0.165	0.047	0.23	0.24

Note: *Spacings larger than one cable diameter will result in a larger voltage drop.

APPENDIX B

Current Carrying Capacity (IN AMPERES)

IEC 60502-1
BS 7629-1



Table B1.6: Multi-core 90°C XLPE / Cross-Linked LSZH / EPR insulated, unarmoured, thermoplastic (PVC / LSZH) sheathed cables
Ambient air temperature: 30°C, Ambient ground temperature: 20°C, Soil thermal resistivity (cable buried in ground): 2.5K.m/W

Conductor Cross-Sectional Area mm ²	Reference Method A (enclosed in conduit in thermally insulating wall etc.)		Reference Method B (enclosed in conduit on a wall or in trunking etc.)		Reference Method C (clipped direct)		Reference Method E (in free air or on a perforated cable tray etc, horizontal or vertical)	
	One 2-Core Cable, Single-Phase a.c. or d.c.	One 3 or 4-Core Cable, 3-Phase a.c.	One 2-Core Cable, Single-Phase a.c. or d.c.	One 3 or 4-Core Cable, 3-Phase a.c.	One 2-Core Cable, Single-Phase a.c. or d.c.	One 3 or 4-Core Cable, 3-Phase a.c.	One 2-Core Cable, Single-Phase a.c. or d.c.	One 3 or 4-Core Cable*, 3-Phase a.c.
	A	A	A	A	A	A	A	A
1.0	14.5	13	17	15	19	17	21	18
1.5	18.5	16.5	22	19.5	24	22	26	23
2.5	25	22	30	26	33	30	36	32
4	33	30	40	35	45	40	49	42
6	42	38	51	44	58	52	63	54
10	57	51	69	60	80	71	86	75
16	76	68	91	80	107	96	115	100
25	99	89	119	105	138	119	149	127
35	121	109	146	128	171	147	185	158
50	145	130	175	154	209	179	225	192
70	183	164	221	194	269	229	289	246
95	220	197	265	233	328	278	352	298
120	253	227	305	268	382	322	410	346
150	290	259	334	300	441	371	473	399
185	329	295	384	340	506	424	542	456
240	386	346	459	398	599	500	641	538
300	442	396	532	455	693	576	741	621
400	-	-	625	536	803	667	865	741

Note: 1. Where a conductor operates at a temperature exceeding 70°C it must be ascertained that the equipment connected to the conductor is suitable for the conductor operating temperature.
2. Where cables in this table are connected to equipment or accessories designed to operate at a temperature not exceeding 70°C, the current ratings given in the equivalent table for 70°C thermoplastic insulated cables must be used.

Voltage Drop (IN mV/A/m)

Table B2.6: Multi-core 90°C XLPE / Cross-Linked LSZH / EPR insulated, unarmoured, thermoplastic (PVC / LSZH) sheathed cables
Ambient temperature: 30°C, Conductor operating temperature: 90°C

Conductor Cross-Sectional Area mm ²	2-Core Cable, d.c. mV/A/m	2-Core Cable, Single-Phase a.c. mV/A/m			3 or 4-Core Cable, 3-Phase a.c. mV/A/m		
		r	x	z	r	x	z
1.0	46	46			40		
1.5	31	31			27		
2.5	19	19			16		
4	12	12			10		
6	7.9	7.9			6.8		
10	4.7	4.7			4.0		
16	2.9	2.9			2.5		
25	1.85	1.85	0.160	1.90	1.60	0.140	1.65
35	1.35	1.35	0.155	1.35	1.15	0.135	1.15
50	0.98	0.99	0.155	1.00	0.86	0.135	0.87
70	0.67	0.67	0.150	0.69	0.59	0.130	0.60
95	0.49	0.50	0.150	0.52	0.43	0.130	0.45
120	0.39	0.40	0.145	0.42	0.34	0.130	0.37
150	0.31	0.32	0.145	0.35	0.28	0.125	0.30
185	0.25	0.26	0.145	0.29	0.22	0.125	0.26
240	0.195	0.200	0.140	0.24	0.175	0.125	0.21
300	0.155	0.160	0.140	0.21	0.140	0.120	0.185
400	0.120	0.130	0.140	0.190	0.115	0.120	0.165

Note: *Spacings larger than one cable diameter will result in a larger voltage drop.

APPENDIX B

Current Carrying Capacity (IN AMPERES)

Table B1.7: Single-core 90°C XLPE / Cross-Linked LSZH / EPR insulated, armoured (non-magnetic armour), thermoplastic (PVC / LSZH) sheathed cables

Ambient air temperature: 30°C, Ambient ground temperature: 20°C, Soil thermal resistivity (cable buried in ground): 2.5K.m/W

IEC 60502-1
BS 5467
BS 6724



Conductor Cross-Sectional Area mm ²	Reference Method C (clipped direct)			Reference Method F (in free air or on a perforated cable tray horizontal or vertical)								
	Touching		2 Cables, Single-Phase a.c. or d.c. flat	Touching			Spaced by One Cable Diameter					
	2 Cables, Single-Phase a.c. or d.c. flat	3 or 4 Cables, 3-Phase a.c. flat		2 Cables, Single-Phase a.c. or d.c. flat	3 Cables, 3-Phase a.c. flat	3 Cables, 3-Phase a.c. trefoil	2 Cables, d.c.		2 Cables, Single-Phase a.c.		3 or 4 Cables, 3-Phase a.c.	
	A	A	A	A	A	Horizontal	Vertical	Horizontal	Vertical	Horizontal	Vertical	
50	237	220	253	232	222	284	270	282	266	288	266	
70	303	277	322	293	285	356	349	357	337	358	331	
95	367	333	389	352	346	446	426	436	412	425	393	
120	425	383	449	405	402	519	497	504	477	485	449	
150	488	437	516	462	463	600	575	566	539	549	510	
185	557	496	587	524	529	688	660	643	614	618	574	
240	656	579	689	612	625	815	782	749	714	715	666	
300	755	662	792	700	720	943	906	842	805	810	755	
400	853	717	899	767	815	1137	1094	929	889	848	797	
500	962	791	1016	851	918	1314	1266	1032	989	923	871	
630	1082	861	1146	935	1027	1528	1474	1139	1092	992	940	
800	1170	904	1246	987	1119	1809	1744	1204	1155	1042	978	
1000	1261	961	1345	1055	1214	2100	2026	1289	1238	1110	1041	

Note: 1. Where a conductor operates at a temperature exceeding 70°C it must be ascertained that the equipment connected to the conductor is suitable for the conductor operating temperature.
2. Where cables in this table are connected to equipment or accessories designed to operate at a temperature not exceeding 70°C, the current ratings given in the equivalent table for 70°C thermoplastic insulated cables must be used.

Voltage Drop (IN mV/A/m)

Table B2.7: Single-core 90°C XLPE / Cross-Linked LSZH / EPR insulated, armoured (non-magnetic armour), thermoplastic (PVC / LSZH) sheathed cables

Ambient temperature: 30°C, Conductor operating temperature: 90°C

Conductor Cross-Sectional Area mm ²	2 Cables, d.c. mV/A/m	Reference Method C & F (clipped direct, on tray or in free air)														
		2 Cables, Single-Phase a.c.						3 or 4 Cables, 3-Phase a.c.								
		Touching			Spaced*			Trefoil and Touching			Flat and Touching			Flat and Spaced*		
		mV/A/m	mV/A/m	mV/A/m	mV/A/m	mV/A/m	mV/A/m	mV/A/m	mV/A/m	mV/A/m	mV/A/m	mV/A/m	mV/A/m	mV/A/m	mV/A/m	mV/A/m
50	0.98	r	x	z	r	x	z	r	x	z	r	x	z	r	x	z
70	0.67	0.99	0.21	1.00	0.98	0.29	1.00	0.86	0.180	0.87	0.84	0.25	0.88	0.84	0.33	0.90
95	0.49	0.68	0.200	0.71	0.69	0.29	0.75	0.59	0.170	0.62	0.60	0.25	0.65	0.62	0.32	0.70
120	0.39	0.51	0.195	0.55	0.53	0.28	0.60	0.44	0.170	0.47	0.46	0.24	0.52	0.49	0.31	0.58
150	0.31	0.41	0.190	0.45	0.43	0.27	0.51	0.35	0.165	0.39	0.38	0.24	0.44	0.41	0.30	0.51
185	0.25	0.33	0.185	0.38	0.36	0.27	0.45	0.29	0.160	0.33	0.31	0.23	0.39	0.34	0.29	0.45
240	0.195	0.27	0.185	0.33	0.30	0.26	0.40	0.23	0.160	0.28	0.26	0.23	0.34	0.29	0.29	0.41
300	0.155	0.21	0.180	0.28	0.24	0.26	0.35	0.180	0.155	0.24	0.21	0.22	0.30	0.24	0.28	0.37
400	0.115	0.170	0.175	0.25	0.195	0.25	0.32	0.145	0.150	0.21	0.170	0.22	0.28	0.20	0.27	0.34
500	0.093	0.145	0.170	0.22	0.180	0.24	0.30	0.125	0.150	0.195	0.160	0.21	0.27	0.20	0.27	0.33
630	0.073	0.125	0.170	0.21	0.165	0.24	0.29	0.105	0.145	0.180	0.145	0.20	0.25	0.190	0.24	0.31
800	0.056	0.105	0.165	0.195	0.150	0.23	0.27	0.092	0.145	0.170	0.135	0.195	0.24	0.175	0.23	0.29
1000	0.045	0.090	0.160	0.190	0.145	0.23	0.27	0.086	0.140	0.165	0.130	0.180	0.23	0.175	0.195	0.26
		0.092	0.155	0.180	0.140	0.21	0.25	0.080	0.135	0.155	0.125	0.170	0.21	0.165	0.180	0.24

Note: *Spacings larger than one cable diameter will result in a larger voltage drop.

APPENDIX B

Current Carrying Capacity (IN AMPERES)

Table B1.8: Multi-core 90°C XLPE / Cross-Linked LSZH / EPR insulated, armoured, thermoplastic (PVC / LSZH) sheathed cables

Ambient air temperature: 30°C, Ambient ground temperature: 20°C, Soil thermal resistivity (cable buried in ground): 2.5K.m/W

IEC 60502-1
BS 5467
BS 6724
BS 7846



Conductor Cross-Sectional Area mm ²	Reference Method C (dipped direct)		Reference Method E (in free air or on a perforated cable tray etc, horizontal or vertical)		Reference Method D (direct in ground or in ducting in ground, in or around buildings)	
	One 2-Core Cable, Single-Phase a.c. or d.c.	One 3 or 4-Core Cable, 3-Phase a.c.	One 2-Core Cable, Single-Phase a.c. or d.c.	One 3 or 4-Core Cable, 3-Phase a.c.	One 2-Core Cable, Single-Phase a.c. or d.c.	One 3 or 4-Core Cable, 3-Phase a.c.
	A	A	A	A	A	A
1.5	27	23	29	25	25	21
2.5	36	31	39	33	33	28
4	49	42	52	44	43	36
6	62	53	66	56	53	44
10	85	73	90	78	71	58
16	110	94	115	99	91	75
25	146	124	152	131	116	96
35	180	154	188	162	139	115
50	219	187	228	197	164	135
70	279	238	291	251	203	167
95	338	289	354	304	239	197
120	392	335	410	353	271	223
150	451	386	472	406	306	251
185	515	441	539	463	343	281
240	607	520	636	546	395	324
300	698	599	732	628	446	365
400	787	673	847	728	-	-

Note: 1. Where a conductor operates at a temperature exceeding 70°C it must be ascertained that the equipment connected to the conductor is suitable for the conductor operating temperature.
2. Where cables in this table are connected to equipment or accessories designed to operate at a temperature not exceeding 70°C, the current ratings given in the equivalent table for 70°C thermoplastic insulated cables must be used.

Voltage Drop (IN mV/A/m)

Table B2.8: Multi-core 90°C XLPE / Cross-Linked LSZH / EPR insulated, armoured, thermoplastic (PVC / LSZH) sheathed cables

Ambient temperature: 30°C, Conductor operating temperature: 90°C

Conductor Cross-Sectional Area mm ²	2-Core Cable, d.c.	2-Core Cable, Single-Phase a.c.			3 or 4-Core Cable, 3-Phase a.c.		
	mV/A/m	r	x	z	r	x	z
1.5	31	1.85	0.160	1.90	1.60	0.140	1.65
2.5	19	1.35	0.155	1.35	1.15	0.135	1.15
4	12	0.98	0.155	1.00	0.86	0.135	0.87
6	7.9	0.67	0.150	0.69	0.59	0.130	0.60
10	4.7	0.49	0.150	0.52	0.43	0.130	0.45
16	2.9	0.39	0.145	0.42	0.34	0.130	0.37
25	1.85	0.31	0.145	0.35	0.28	0.125	0.30
35	1.35	0.25	0.145	0.29	0.22	0.125	0.26
50	0.98	0.20	0.140	0.24	0.175	0.125	0.21
70	0.67	0.16	0.140	0.21	0.140	0.120	0.185
95	0.49	0.13	0.140	0.190	0.115	0.120	0.165
120	0.39						
150	0.31						
185	0.25						
240	0.195						
300	0.155						
400	0.120						

Note: *Spacings larger than one cable diameter will result in a larger voltage drop.

APPENDIX C

Rating Factor for Ambient Temperature



The current-carrying capacities in this work standard are based upon the following reference ambient temperatures:

- i) For non-sheathed and sheathed cables in air, irrespective of the installation method : 30°C
- ii) For buried cables, either directly in the soil or in ducts in the ground : 20°C

When the ambient temperature in the intended location of the non-sheathed or sheathed cables differs from the reference ambient temperature, please refer to the appropriate rating factors as below table (Table C1.1 and C1.2).

Table C1.1: Rating factors for ambient air temperatures other than 30°C to be applied to the current-carrying capacities for cables in free air.

Ambient Temperature °C	PVC	XLPE
25	1.03	1.02
30	1.00	1.00
35	0.94	0.96
40	0.87	0.91
45	0.79	0.87
50	0.71	0.82
55	0.61	0.76
60	0.50	0.71
65	-	0.65
70	-	0.58
75	-	0.50
80	-	0.41
85	-	-
90	-	-
95	-	-

Table C1.2: Rating factors for ambient ground temperatures other than 20°C to be applied to the current-carrying capacities for cables buried to ground.

Ground Temperature °C	PVC	XLPE
10	1.10	1.07
15	1.05	1.04
20	1.00	1.00
25	0.95	0.96
30	0.89	0.93
35	0.84	0.89
40	0.77	0.85
45	0.71	0.80
50	0.63	0.76
55	0.55	0.71
60	0.45	0.65
65	-	0.60
70	-	0.53
75	-	0.46
80	-	0.38

Rating Factor for Soil Thermal Resistivities

Table C1.3: Rating factors for cables buried direct in the ground or in an underground conduit system to BS EN 50086-2-4 for soil thermal resistivities other than 2.5 K.m/W to be applied to the current-carrying capacities for Reference Method D

Thermal resistivity K.m/W	0.5	0.8	1	1.5	2	2.5	3
Rating factor for cables in buried ducts	1.28	1.20	1.18	1.1	1.05	1	0.96
Rating factor for direct buried cables	1.88	1.62	1.5	1.28	1.12	1	0.90

Note:

1. The rating factors given have been averaged over the range of conductor sizes and types of installation included in the relevant tables in this appendix. The overall accuracy of rating factors is within ± 5%.
2. The rating factors are applicable to cables drawn into buried ducts For cables laid direct in the ground the rating factors for thermal resistivities less than 2.5 K.m/W will be higher. Where more precise values, are required they may be calculated by methods given in BS 7769 (BS IEC 60287).
3. The rating factors are applicable to ducts buried at depths of up to 0.8 m.

APPENDIX C

Table C2.1: Rating factors for one circuit or one multicore cable or for a group of circuits, or a group of multicore cables, to be used with current-carrying capacities of Tables B1.1 to Tables B1.8.



Arrangement (cables touching)	Number of circuits or multicore cables												To be used with current-carrying capacities, Reference
	1	2	3	4	5	6	7	8	9	12	16	20	
Bunched in air, on a surface, embedded or enclosed	1.00	0.80	0.70	0.65	0.60	0.57	0.54	0.52	0.50	0.45	0.41	0.38	Methods A to F
Single layer on wall or floor	1.00	0.85	0.79	0.75	0.73	0.72	0.72	0.71	0.70	0.70	0.70	0.70	Method C
Single layer multicore on a perforated horizontal or vertical tray cable system	1.00	0.88	0.82	0.77	0.75	0.73	0.73	0.72	0.72	0.72	0.72	0.72	Methods E and F
Single layer multicore on cable ladder system or cleats, etc	1.00	0.87	0.82	0.80	0.80	0.79	0.79	0.78	0.78	0.78	0.78	0.78	

Note:

- These factors are applicable to uniform groups of cables, equally loaded.
- Where horizontal clearances between adjacent cables exceeds twice their overall diameter, no rating factor need be applied.
- The same factors are applied to:
 - groups of two or three single-core cables;
 - multicore cables.
- If a system consists of both two- and three-core cables, the total number of cables is taken as the number of circuits, and the corresponding factor is applied to the tables for two loaded conductors for the two-core cables, and to the Tables for three loaded conductors for the three-core cables.
- If a group consists of n single-core cables it may either be considered as n/2 circuits of two loaded conductors or n/3 circuits of three loaded conductors.
- The rating factors given have been averaged over the range of conductor sizes and types of installation included in Tables B1.1 to B1.8 the overall accuracy of tabulated values is within 5%.
- For some installations and for other methods not provided for in the above table, it may be appropriate to use factors calculated for specific cases, see for example Table C3.1 to C3.2.
- When cables having differing conductor operating temperature are grouped together, the current rating is to be based upon the lowest operating temperature of any cable in the group.
- If, due to known operating conditions, a cable is expected to carry not more than 30% of its grouped rating, it may be ignored for the purpose of obtaining the rating factor for the rest of the group. For example, a group of N loaded cables would normally required a group rating factor of C_g applied to the tabulated It. However, if M cables in the group carry loads which are not greater than 0.3 C_glt amperes the other cables can be sized by using the group rating factor corresponding to (N-M) cables.

Table C2.2: Rating factors for more than one circuit, cables laid directly in the Ground-Reference Method D in Tables A1.1 to A1.5. Single-core or multicore cables.

Number of circuits	Cable-to-cable clearance (a)				
	Nil (cables touching)	One cable diameter	0.125m	0.25m	0.5m
2	0.75	0.80	0.85	0.90	0.90
3	0.65	0.70	0.75	0.80	0.85
4	0.60	0.60	0.70	0.75	0.80
5	0.55	0.55	0.65	0.70	0.80
6	0.50	0.55	0.60	0.70	0.80

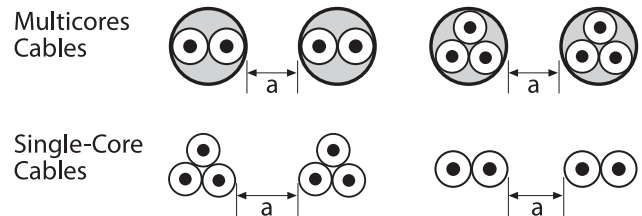

Note:

- Values given apply to an installation depth of 0.7m and a soil thermal resistivity of 2.5K.m/W. These are average values for the range of cable sizes and types quoted for Table B1.1 to B1.8. The process of averaging, together with rounding off, can result in some cases in errors of up to ± 10%. (Where more precise values are required they may be calculated by methods given in BS 7769 (BS IEC 60287)).
- In case of a thermal resistivity lower than 2.5 K.m/W the rating factors can, in general, be increased and can be calculated by the methods given in BS 7769 (BS IEC 60287).

APPENDIX C

Table C2.3: Rating factors for more than one circuit, cables laid in ducts in the ground - Reference Method D in Tables B1.1 to B1.8



i. Multicore Cables in a Single-Way Ducts

Number of cables	Duct-to-duct Clearance (a)			
	Nil (ducts touching)	0.25m	0.5m	1.0m
2	0.85	0.90	0.95	0.95
3	0.75	0.85	0.90	0.95
4	0.70	0.80	0.85	0.90
5	0.65	0.80	0.85	0.90
6	0.60	0.80	0.80	0.90

Multicores Cables

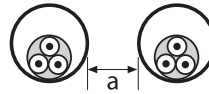

Note:

- Values given apply to an installation depth of 0.7m and a soil thermal resistivity of 2.5K.m/W. These are average values for the range of cable sizes and types quoted for Table B1.1 to B1.8. The process of averaging, together with rounding off, can result in some cases in errors of up to $\pm 10\%$. (Where more precise values are required they may be calculated by methods given in BS 7769 (BS IEC 60287)).
- In case of a thermal resistivity lower than 2.5 K.m/W the rating factors can, in general, be increased and can be calculated by the methods given in BS 7769 (BS IEC 60287).

ii. Single-Core Cables in Non-Ferrous Single-Way Ducts

Number of single-core circuits of 2 or 3 cables	Duct-to-duct Clearance (a)			
	Nil (ducts touching)	0.25m	0.5m	1.0m
2	0.80	0.90	0.90	0.95
3	0.70	0.80	0.85	0.90
4	0.65	0.75	0.80	0.90
5	0.60	0.70	0.80	0.90
6	0.60	0.70	0.80	0.90

Single-Cores Cables

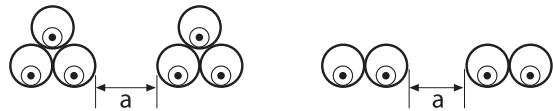

Note:

- Values given apply to an installation depth of 0.7m and a soil thermal resistivity of 2.5K.m/W. These are average values for the range of cable sizes and types quoted for Table B1.1 to B1.8. The process of averaging, together with rounding off, can result in some cases in errors of up to $\pm 10\%$. (Where more precise values are required they may be calculated by methods given in BS 7769 (BS IEC 60287)).
- In case of a thermal resistivity lower than 2.5 K.m/W the rating factors can, in general, be increased and can be calculated by the methods given in BS 7769 (BS IEC 60287).

APPENDIX C

Table C3.1

Rating factors for groups of more than one multicore cables, to be applied to reference current-carrying capacities for multicore cables in free air
 - Reference Method E in Tables B 1.1 to B1.8



Installation Method in Table A1.1 to A1.5		Number of trays or ladders	Number of cables per tray or ladder						
			1	2	3	4	6	9	
Perforated cable tray systems (Note 3)	31		1	See item 4 of Table C2.1					
			2	1.00	0.87	0.80	0.77	0.73	0.68
			3	1.00	0.86	0.79	0.76	0.71	0.66
			6	1.00	0.84	0.77	0.73	0.68	0.64
Perforated cable tray systems (Note 3)	31		1	1.00	1.00	0.98	0.95	0.91	-
			2	1.00	0.99	0.96	0.92	0.87	-
			3	1.00	0.98	0.95	0.91	0.85	-
Vertical perforated cable tray systems (Note 4)	31		1	See item 4 of Table C2.1					
			2	1.00	0.88	0.81	0.76	0.71	0.70
Vertical perforated cable tray systems (Note 4)	31		1	1.00	0.91	0.89	0.88	0.87	-
			2	1.00	0.91	0.88	0.87	0.85	-
Unperforated cable tray systems	30		1	0.97	0.84	0.78	0.75	0.71	0.68
			2	0.97	0.83	0.76	0.72	0.68	0.63
			3	0.97	0.82	0.75	0.71	0.66	0.61
			6	0.97	0.81	0.73	0.69	0.63	0.58
Cable ladder systems, cleats, wire mesh tray, etc (Note 3)	32		1	See item 4 of Table C2.1					
			2	1.00	0.86	0.80	0.78	0.76	0.73
			3	1.00	0.85	0.79	0.76	0.73	0.70
			6	1.00	0.84	0.77	0.73	0.68	0.64
Cable ladder systems, cleats, wire mesh tray, etc (Note 3)	32		1	1.00	1.00	1.00	1.00	1.00	-
			2	1.00	0.99	0.98	0.97	0.96	-
			3	1.00	0.98	0.97	0.96	0.93	-

Note 1: Values given are averages for the cable types and range of conductor sizes considered in Tables B1.1 to B1.8. The spread of values is generally less than 5%.

Note 2: Factors apply to single layer groups of cables as shown above and do not apply when cables are installed in more than one layer touching each other. Values for such installations may be significantly lower and must be determined by an appropriate method.

Note 3: Values are given for the vertical spacing between cable trays of 300mm and at least 20mm between cable trays and wall. For closer spacing the factors should be reduced.

Note 4: Values are given for horizontal spacing between cable trays of 225mm with cable trays mounted back to back. For closer spacing the factors should be reduced.

APPENDIX C

Table C3.2

Rating factors for groups of one or more circuits of single-core cables to be applied to reference current-carrying capacity for one circuit of single-core cables in free air
- Reference Method F in Tables B1.1 to B1.8



Installation Method in Table A1.1 to A1.5		Number of trays or ladders	Number of Three-Phase circuits per tray or ladder			Use as a multiplier to rating for:	
			1	2	3		
Perforated cable tray systems (Note 3)	31		1	0.98	0.91	0.87	Three cables in horizontal formation
			2	0.96	0.87	0.81	
			3	0.95	0.85	0.78	
Vertical perforated cable tray systems (Note 4)	31		1	0.96	0.86	-	Three cables in vertical formation
			2	0.95	0.84	-	
Cable ladder systems, cleats, wire mesh tray, etc. (Note 3)	32 33 34		1	1.00	0.97	0.96	Three cables in horizontal formation
			2	0.98	0.93	0.89	
			3	0.97	0.90	0.86	
Perforated cable tray systems (Note 3)	31		1	1.00	0.98	0.96	Three cables in trefoil formation
			2	0.97	0.93	0.89	
			3	0.96	0.92	0.86	
Vertical perforated cable tray systems (note 4)	31		1	1.00	0.91	0.89	Three cables in trefoil formation
			2	1.00	0.90	0.86	
Cable ladder systems, cleats, wire mesh tray, etc. (Note 3)	32 33 34		1	1.00	1.00	1.00	Three cables in trefoil formation
			2	0.97	0.95	0.93	
			3	0.96	0.94	0.90	

Note 1: Values given are averages for the cable types and range of conductor sizes considered in Tables B1.1 to B1.8. The spread of values is generally less than 5%.

Note 2: Factors apply to single layer groups of cables (or trefoil groups) as shown above and do not apply when cables are installed in more than one layer touching each other. Values for such installations may be significantly lower and must be determined by an appropriate method.

Note 3: Values are given for vertical spacing between cable trays of 300mm and at least 20mm between cable trays and wall. For closer spacing the factors should be reduced.

Note 4: Values are given for horizontal spacing between cable trays of 225mm with cable trays mounted back to back. For closer spacing the factors should be reduced.

Note 5: For circuits having more than one cable in parallel per phase, each three-phase set of conductors is to be considered as a circuit for the purpose of this table.

Identification of Cores in Cables

In March 2004, the Amendment No.2: AMD 14905 to BS 7671:2001 (IEE Wiring Regulations Sixteenth Edition) has been harmonized with the CENELEC Standard HD 384.5.514: Identification including 514.3: Identification of conductor and with the CENELEC Harmonization Document HD 308 S2: 2001 Identification of cores in cables and flexible cords.

The change in cable core colours is a major development that will affect the way wiring cable colours are distinguished and installed. Currently, for three phase fixed electrical installations, the wiring cable colours for the line connections are red, yellow and blue respectively. The new three phase harmonized cable core colours will be brown, black and grey, following that of the new BS 7671:2008 Requirements for electrical installations, IEE Wiring Regulations, 17th Edition. A number of countries in the European Union as well as Hong Kong and Singapore have implemented these harmonized cable core colours.

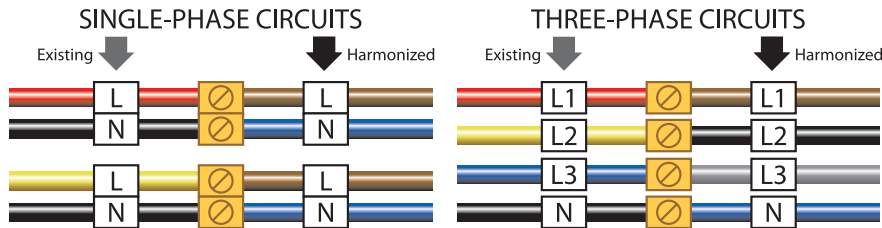

For any new electrical installation that involved extension from existing wiring system, BS 7671 has been modified to align with these cable core colours where suitable marking/labelling method eg. Colour tapes, sleeves, discs or by alphanumeric (letters and/or numbers) is allowed. See below figures:-

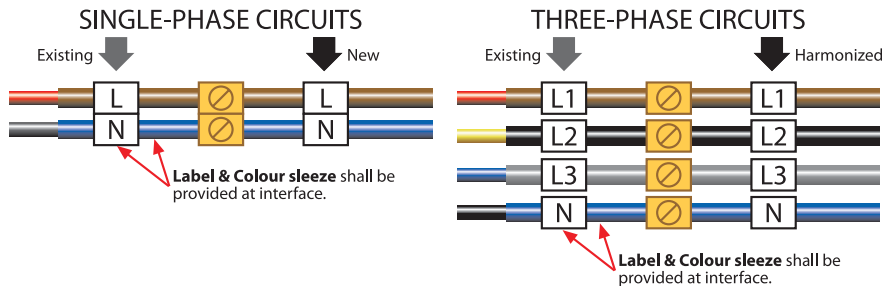

Function	Alpha-Numeric	Existing Core Colours	New Harmonized Core Colour
Protective conductor	-	Green / Yellow	Green / Yellow
Functional earthing conductor	-	Cream	Cream
AC Power Circuit			
Single Phase Circuit			
- Phase	L	Red	Brown
- Neutral	N	Black	Blue
Three Phase Circuit			
- Phase1	L1	Red	Brown
- Phase2	L2	Yellow	Black
- Phase3	L3	Blue	Grey
- Neutral	N	Black	Blue
DC Two-Wire Unearthed Circuit			
- Positive	L+	Red	Brown
- Negative	L-	Black	Grey
DC Two-Wire Earthed Circuit			
- Positive (of negative earth)	L+	Red	Brown
- Negative (of negative earth)	M	Black	Blue
- Positive (of positive earth)	N	Black	Blue
- Negative (of positive earth)	L-	Blue	Grey
DC Three-Wire Circuit			
- Positive	L+	Red	Brown
- Mid-wire (may be earthed)	M	Black	Blue
- Negative	L-	Blue	Grey

A GUIDE TO FIRE PERFORMANCE TESTS & STANDARDS FOR CABLES

Cables and wires are like blood vessels in the body which keep us alive. They supply the essential energy to every part of residential, public, commercial and industrial buildings as well as vital infrastructure facilities, to provide power for lighting, computer systems, electrical appliances and machinery, etc. Comply with various relevant performance standards to ensure integrity and reliability.

This guide provides you with an idea of the mandated tests and standards to ensure cables and wires meet international fire performance requirements.

TYPES OF FIRE PERFORMANCE CABLES

It is important for cables to have fire survival properties because they are widely distributed throughout a building and can be the main cause of fire transmission to unaffected areas. There are 2 types of characteristics for Fire Performance: Active - which ensures the cable, continues to transmit power and signals during a fire, and Passive which limits the spread of fire that can cause severe damage to property and reduces the emission of fumes and toxic gases that can lead to loss of human lives.

These safety features are necessary to allow occupants of buildings and facilities to have the time to evacuate without being hurt or overcome by fire, toxic gases and fumes.

In Europe and the United States, where most of the fire performance standards originated, there is a slight difference in concerns over fire behaviour. The European countries are concerned about all aspects of fire-affected cables, including harmful halogen, smoke and gas contents, whereas the concern over in the United States is the flame spread and smoke characteristics from cables.

Cables are therefore rated for their various Fire Resistant, Flame Retardant, Low Smoke Zero Halogen (LSZH) and Low Smoke Fume (LSF) characteristics.

FLAME RETARDANT CABLES

Flame Retardant cables are designed to minimise the spread of flame in the event of a fire. Whether it is a single wire or a bundled wire cable, it is supposed to retard flame spread so that the fire may ideally be limited to a small area and allow for emergency response to put it out. Our PVC-based cables have this characteristic and are widely used for their low cost.

LOW SMOKE AND FUME CABLES (LSF)

LSF cables are slow to ignite and they burn slowly. LSF cables emit much smaller amount of smoke and fumes, with characteristics similar to that of LSZH-FRT cables. Although its emission will still have halogen but the content is much lesser than that from PVC cables. To ensure better fire performance, LSF cables are manufactured with flame retardant PVC blended with HCL and smoke absorbent material for maximum efficiency. Low Smoke Zero Halogen Flame Retardant Cables (LSZH-FRT)

Halogens are harmful non-metal elements such as fluorine (F), chlorine (Cl), bromine (Br), iodine (I), and astatine (At). FRT cables are designed with special materials not only with self-extinguishing property, but also with low smoke and fume emissions without halogens, as well as an absence of toxic gas emission in case of combustion. Thus, LSZH-FRT cables outperform PVC and LSF cables with additional protection from fire spread and the emission of toxic gas and corrosive elements. These cables are suitable for use in inadequately ventilated areas such as those in aircraft, ships, and military facilities.

FIRE RESISTANT CABLES

Fire Resistant cables are designed with superior fire resistant property to continue to operate in the event of a fire for a specific period of time (usually between 30 and 180 minutes). They are specified for used in vital installations and essential support facilities, such as a fire alarm system, as they are designed to withstand fire and maintain circuit integrity. In such cables the stranded annealed copper conductor is sealed with a fire-resisting mica tape wrap, so that even after the insulation has been burnt phase-to phase and phase-to-earth contact can be prevented. They are also designed to withstand mechanical shock and perform under wet condition.

STANDARDS FOR FLAME RETARDANCY (European & British Standards)

There are three classes of tests for flame propagation in cables. They are the IEC 60332-1, IEC 60332-2 and IEC 60332-3 standards. The European Committee for Electromechanical Standardization (CENELEC) - which adopts the standards of the International Electro-technical Committee (IEC) - uses the first two to assess flame propagation characteristics of a single wire, and the IEC 60332-3 for similar characteristics test for bundled cables, which is more stringent.

The British Standards for flame propagation test for single wire and bundled wires and cables are the BS EN 60332-1 (formerly known as BS4066-1) and BS EN 50266-2 (formerly known as BS 4066-3).

FLAME TEST ON SINGLE VERTICAL INSULATED WIRE/CABLE (IEC 60332-1, BS EN 60332-1)

The flame propagation characteristic of a single wire or cable is tested using a 60cm cable specimen that is fixed vertically in a metal chamber. A calibrated gas burner adjusted with the recommended flow rates of gas and air is lighted and applied at 45-degree angle on the surface of the test sample at 475 mm (+/- 5mm) from the lower edge of the upper horizontal clamp. The flame is applied continuously for a duration (60 - 480 sec) corresponding to the diameter of the wire/cable. After the flame has been extinguished, the specimen is cleaned and examined. It passes the test if the charring does not reach 50mm from the lower edge of the top clamp, or the charring does not extend beyond 475mm from the point of flame application.

FLAME TEST ON BUNCHED WIRES/CABLES (IEC 60332-3, BS EN 50266-2)

This test comprises four categories (A, B, C & D) according to the volume of combustible material per metre of cable. It determines the bunched cables ability to limit flame spread.

The test sample consists of several pieces of cable each 3.5 m long, in order to have the required quantity of combustible material per metre of specimen. The cables are installed in a metal chamber on the front of a vertical ladder and are subjected to a gas burner flame for a specified time under controlled air flow. At the end of the specified duration, the burnt and charred portion of the cable must not be more than 2.5 m from the burner point.

STANDARDS FOR FIRE RESISTANCE

IEC 60331-11 (APPARATUS 750°C) IEC 60331-21 (CABLES RATED UP TO 0.6/1.0kV)

To verify circuit integrity in the event of a fire, the cable sample is held on a flame at about 750°C for 3 hours under its rated voltage. The sample must then be re-energised in not less than 12 hours after the test, and to pass, the specimen must not breakdown and circuit integrity must be maintained.

BS6387

This test is performed to investigate the cable's ability to maintain circuit integrity under three conditions - fire only, fire with spray of water, and fire with mechanical shock.

Resistance to fire - the cable while performing at its rated voltage is subjected to gas burner fire at the specified temperature for the respective categories - Category A - 3 hours at 650°C, Category B - 3 hours at 750°C and Category C - 3 hours at 950°C.

Resistance to fire and water (Category W) is another cable specimen with rated voltage running is exposed for 15 minutes to flame at 650°C and a further 15 minutes to fire and a continuous spray of water.

Resistance to fire and mechanical shock in this test a new cable sample with rated voltage running is mounted on a vertical panel which is struck with a steel bar for 15 minutes while subjected to a flame. The burning temperatures required for the respective categories are Category X (650°C), Category Y (750°C) and Category Z (950°C).

STANDARDS FOR HALOGEN, SMOKE EMISSION, CORROSIVITY AND TOXICITY

SMOKE DENSITY (IEC 61034-2, BS EN 61034-2)

To measure the density of smoke from a burning cable, samples are placed horizontally in a 3 square metre metal cabinet and burned by flame from 100 cubic cm of alcohol in a metal tray. A fan is used to ensure uniformity of the smoke and light transmittance is measured by a photometric system in the cabinet. The result is expressed as percentage light transmittance and the specimen is rated to have passed the test if the value is more than 60%, as the higher the percentage the less smoke is emitted.

HALOGEN EMISSION (IEC 60754-1, BS EN 50267-2-1)

To determine the amount of corrosive gases, such as fluorine, chlorine, bromine, astatine and iodine released by the cable, samples of non-metallic materials (1g) are burned in a tubular oven at up to 800°C. Controlled air flow inside the chamber absorbs the resulting gases in water, which is tested for its acidity. If the specimen yields less than 5 mg/g of hydrochloric acid it is rated Halogen Free, but if the yield is between 5 mg/g and 15 mg/g it is classed as Low Smoke & Fumes. The results do not determine whether the specimen is totally halogen free.

SMOKE CORROSIVELY (IEC 60754-2, BS EN 50267-2-2)

This method determines the corrosiveness of the gases released from the cables by burning the insulation material in a furnace at ≤935°C with rated air supply for 30 minutes. The effluent gases are absorbed into distilled water, which is then measured for its pH and conductivity. A pH-value of above 4.3 and conductivity of over 10µS / mm must be achieved.

TOXICITY INDEX (ES713)

This Naval Engineering Standard method is used to analyse noxious gas emitted from the burning specimen and the amount that each of the gas can cause fatality. Sample of the cable insulating material (~1.0 g) is burned in a chamber with a volume of 0.7-1m³ and the gases emitted during combustion are detected and collected in order to determine the quantities of the elements, such as carbon dioxide, carbon monoxide, sulphur dioxide, nitric oxide, acids, ammonia, etc. The Toxicity Index is derived from the calculated quantity of each gas produced when 100g (scaled up) of the material is burnt in air in a volume of 1m³ and the particular resulting concentration fatal to human when exposed to it for 30 minutes, thus determining the critical toxicity factor. The higher the index, the more toxic the insulating material when burnt in a fire. For example, the toxicity index of a FRT cable is generally known to be lower than 5.

OTHER RELEVANT STANDARDS

LIMITING OXYGEN INDEX (LOI) (ISO4589-2, BS ISO7211-3)

LOI is defined as the minimum concentration of oxygen required to support flaming combustion in a flowing air mixture of oxygen and nitrogen (in this instance, the downward burning of a vertically-mounted test specimen such as a candle.) The oxygen concentration is recorded as volume percentage. A higher LOI value (oxygen concentration) means better flame retardancy. For example, with 21% oxygen index the material will burn by itself automatically at room temperature; LSZH cables require a higher index between 33% and 42%. The test method allows accuracy of + 0.5% to be achieved.

TEMPERATURE INDEX (TI) (ISO4589, BS 2782.1)

Research has shown that compared to the conventional oxygen index, higher temperature at which a material will burn in air is a better determinant of combustibility. When air temperature rises, the Oxygen Index Value falls, thus, the test for Temperature Index (TI) has been developed from the LOI method. The apparatus used for the TI test is essentially similar to that of the LOI test but the incoming combustion gas is heated. It tests the flammability of the sample with a small flame to find the optimum temperature at which the specimen will burn automatically. When a specimen burns automatically in the air with 21% oxygen, the temperature at this point is known as the TI. In the case of coal, the oxygen index will drop to 21% and it will burn automatically when the air temperature reaches 150°C. This temperature for coal is recorded as its TI.



1. APPLICATION OF TERMS & CONDITIONS

These conditions govern the sales and purchase of goods ordered by Buyer from Seller ("the goods") and shall override any terms and conditions whether previously or hereafter stipulated incorporated or referred to by Buyer whether orally in its purchase order or other documents.

2. DELIVERY

- Any time for delivery named by Seller is an estimate only and Seller is not liable to make good any damage or loss arising out of any such delay.
- Delivery shall be deemed to have been made if seller delivers the goods to the location specified by the Buyer and Delivery Order is endorsed by any person present thereat. Seller not responsible to ensure the goods have been delivered to or is collected by Buyer or its authorized personnel and shall not be liable for any loss or damage to Buyer by reason of unauthorized collection of the goods.
- Should Buyer fail to take delivery of goods, Seller shall be entitled (without derogation of its rights under Law) to charge Buyer for storage and insurance for the goods calculated from the date fixed for delivery.
- The Seller reserves the right to deliver goods by installments and each installment shall be deemed to have been sold under a separate contract. Failure to deliver any installment shall not entitle the buyer to repudiate the contract.
- Off loading and/or handling will in all events be the responsibility of the Buyer.
- If the goods to be delivered are, at the Buyer's discretion, delivered to the destination other than the Buyer's premises, the Seller will arrange such delivery for the Buyer and all costs for carriage and insurance will be to the Buyer's account.
- Availability of the goods when offered ex-stock is subject to such goods being sold in another transaction between the date when the Seller advises the goods are available, and the date when it receives the Buyer's order. Any delivery time offered for products made to special customer order is indicative only, and the Seller shall not be liable for any loss or damage whatsoever arising as a consequence or result of any such failure to deliver.

3. PRICE

The quoted price for the goods are subject to change in the event of any imposition or increase in taxes, levies or duties whatsoever on the goods, its components or raw materials.

4. PAYMENT

Payments for the goods shall be made within the time stipulated in the invoice. Interest at 1.5% per month will be charged on late payment.

5. TIME OF THE ESSENCE

Time within which the Buyer is to pay for the goods shall be of the essence of this Contract.

6. ACCEPTANCE

Buyer shall inspect the goods immediately upon delivery. Unless Seller receives notice that the goods are not in accordance with the Buyer's order and the goods returned to Seller within 24 hours from the date of delivery, the goods shall be deemed to have been accepted by the Buyer PROVIDED ALWAYS Seller will not accept return of used goods and Buyer shall not reject any goods which are in accordance with the Buyer's order.

7. DESCRIPTION

Notwithstanding any description of the goods given by the Seller or Buyer, no sale of goods shall constitute or be construed as a sale by description.

8. WARRANTIES

Save and except for written warranties (if any) given by Seller, the Seller does not give any warranties as to the quality, state, condition or fitness of the goods or their suitability for any purpose or for use under any specific conditions, notwithstanding that such purpose or condition may be known or made known to Seller.

9. DEFECTS

Save and except as notified pursuant to Clause 6) above, Seller shall be under no liability to Buyer either in contract or tort for loss, injury or damage sustained by Buyer or any third party by reason of defects in the goods whether latent or otherwise but Buyer will keep Seller indemnified against any such claim.

10. TITLE

Title to the goods remains vested in Seller receives the full purchase price. If such payment is overdue, the Seller may without prejudice to any other rights sue for the purchase price, recover or re-sell the goods and the Buyer grants the Seller, its servants/agents the right and/or license to enter the Buyer's premise and/or any other premise where the goods are stored. If any of the goods are sold by Buyer before title has passed to Buyer, Buyer shall hold the proceeds of sale and all rights against purchaser in trust for Seller.

11. RISK

Risk passes to Buyer upon delivery of goods to Buyer.

12. DEFAULT

If Buyer fail to pay Seller on due date, commits a breach of any of its obligation herein, becomes insolvent or commits an act of bankruptcy, Seller may without prejudice to its other rights and without giving any notice, suspend/cancel further deliveries, stop any delivery in transit under this Contract or any other contracts and/or limit/cancel the Buyer's credit as to time and/or amount for executed, executory or future orders, and/or request for securities or guarantees. Seller shall not be liable to Buyer for any damages which Buyer may suffer or incur by reason thereof.

13. CANCELLATION OF CREDIT

Notwithstanding anything herein contained, Seller reserves the right to limit/cancel the credit of the Buyer as to time and/or amount without giving any reasons thereof and to demand full settlement immediately of all sums that may be owing by Buyer notwithstanding that the credit period has not expired.

14. FORCE MAJEURE

Seller shall not be liable to Buyer for failure to deliver the goods by reason of any breakdown of plant, fire, explosion, Act of God, or outbreak of hostilities, national emergency, industrial disputes, shortage of labour, raw materials, energy or any causes beyond Seller's control and which seller is unable to prevent by the exercise of reasonable diligence, whether of the class of causes enumerated herein or not.

15. APPROPRIATION OF PAYMENTS

All payments received from the Buyer will be applied towards settlement of the Buyer's oldest debts comprising the earliest invoices, debit notes (including debit notes for overdue interest) and other charges howsoever arising PROVIDED ALWAYS Seller may appropriate any payments towards account of interest before principal in respect of any debt as the Seller shall in its absolute discretion deem fit.

16. STATEMENT OF ACCOUNT

All amounts stated in the invoices and statement of accounts of Seller shall be conclusive of the amounts due and owing by Buyer to Seller and shall be binding against Buyer in any legal proceedings.

17. RIGHTS OF SET-OFF

Seller entitled to set-off against Buyer's debts all monies now or hereafter standing to the credit of Buyer's account with Seller and for this purpose Buyer shall give irrevocable authority to Seller to collect on behalf of Buyer and give valid receipt and discharge in respect of all such monies owing to the Buyer.

18. WAIVER

No failure or delay by the Seller in exercising any rights hereunder shall operate as a waiver hereof nor shall any single or partial exercise of right preclude any further exercise thereof or the exercises of any other right.

19. SALE OF GOODS ACT ("the Act")

The terms and conditions in favour of the Seller hereunder shall be in addition to and not in substitution for any term condition warranty expressed or implied in favour of the Seller under the Act or any statutory and re-enactment thereto for the time being enforced.

20. INFRINGEMENT OF PATENTS DESIGNS

Buyer shall indemnify Seller against all damages, claims, costs and expenses which Seller may become liable as a result or work done or goods sold in accordance with Buyer's specifications which involve infringement of any patents, registered designs or trademarks.

21. NOTICES

Any notices, communications or demands shall be deemed to have been sufficiently given if sent by prepaid post to the address of the addressee stated herein or to the addressee's last known place of business and shall be presumed to have reached the address in ordinary course of post.

General Disclaimer We have taken reasonable measures to ensure that the information and data represented in this catalogue is accurate and current. However, Tai Sin makes no express or implied warranty regarding such information or data, and hereby expressly disclaims all responsibility and legal liability to persons or entities that use or access its content, based on their reliance on any information or data that is available through this catalogue. We are not liable for all expenses, losses, damages and costs you might incur as a result of the information being inaccurate or incomplete in any way, and for any reason.